



DSP-AX620

*Natural Sound AV Amplifier
Amplificateur audio-vidéo*

OWNER'S MANUAL
MODE D'EMPLOI
BEDIENUNGSANLEITUNG
BRUKSANVISNING
MANUALE DI ISTRUZIONI
MANUAL DE INSTRUCCIONES
GEBRUIKSAANWIJZING

CAUTION: READ THIS BEFORE OPERATING YOUR UNIT.

- 1 To assure the finest performance, please read this manual carefully. Keep it in a safe place for future reference.
- 2 Install this unit in a well ventilated, cool, dry, clean place with at least 30 cm on the top, 20 cm on the right and left, and 10 cm at the back of this unit for ventilation space — away from direct sunlight, heat sources, vibration, dust, moisture, and/or cold.
- 3 Locate this unit away from other electrical appliances, motors, or transformers to avoid humming sounds. To prevent fire or electrical shock, do not place this unit where it may get exposed to rain, water, and/or any type of liquid.
- 4 Do not expose this unit to sudden temperature changes from cold to hot, and do not locate this unit in a environment with high humidity (i.e. a room with a humidifier) to prevent condensation inside this unit, which may cause an electrical shock, fire, damage to this unit, and/or personal injury.
- 5 On the top of this unit, do not place:
 - Other components, as they may cause damage and/or discoloration on the surface of this unit.
 - Burning objects (i.e. candles), as they may cause fire, damage to this unit, and/or personal injury.
 - Containers with liquid in them, as they may cause electrical shock to the user and/or damage to this unit.
- 6 Do not cover this unit with a newspaper, tablecloth, curtain, etc. in order not to obstruct heat radiation. If the temperature inside this unit rises, it may cause fire, damage to this unit, and/or personal injury.
- 7 Do not plug in this unit to a wall outlet until all connections are complete.
- 8 Do not operate this unit upside-down. It may overheat, possibly causing damage.
- 9 Do not use force on switches, knobs and/or cords.
- 10 When disconnecting the power cord from the wall outlet, grasp the plug; do not pull the cord.
- 11 Do not clean this unit with chemical solvents; this might damage the finish. Use a clean, dry cloth.
- 12 Only voltage specified on this unit must be used. Using this unit with a higher voltage than specified is dangerous and may cause fire, damage to this unit, and/or personal injury. YAMAHA will not be held responsible for any damage resulting from use of this unit with a voltage other than specified.
- 13 To prevent damage by lightning, disconnect the power cord from the wall outlet during an electrical storm.
- 14 Take care of this unit so that no foreign objects and/or liquid drops inside this unit.
- 15 Do not attempt to modify or fix this unit. Contact qualified YAMAHA service personnel when any service is needed. The cabinet should never be opened for any reasons.
- 16 When not planning to use this unit for long periods of time (i.e. vacation), disconnect the AC power plug from the wall outlet.
- 17 Be sure to read the “TROUBLESHOOTING” section on common operating errors before concluding that this unit is faulty.
- 18 Before moving this unit, press **STANDBY/ON** to set this unit in the standby mode, and disconnect the AC power plug from the wall outlet.
- 19 **VOLTAGE SELECTOR (China and General models only)**
The **VOLTAGE SELECTOR** on the rear panel of this unit must be set for your local main voltage **BEFORE** plugging into the AC main supply. Voltages are 110/120/220/240 V AC, 50/60 Hz.

This unit is not disconnected from the AC power source as long as it is connected to the wall outlet, even if this unit itself is turned off. This state is called the standby mode. In this state, this unit is designed to consume a very small quantity of power.

■ For U.K. customers

If the socket outlets in the home are not suitable for the plug supplied with this appliance, it should be cut off and an appropriate 3 pin plug fitted. For details, refer to the instructions described below.

Note

- The plug severed from the mains lead must be destroyed, as a plug with bared flexible cord is hazardous if engaged in a live socket outlet.

■ Special Instructions for U.K. Model

IMPORTANT

THE WIRES IN MAINS LEAD ARE COLOURED IN ACCORDANCE WITH THE FOLLOWING CODE:

Blue: NEUTRAL

Brown: LIVE

As the colours of the wires in the mains lead of this apparatus may not correspond with the coloured markings identifying the terminals in your plug, proceed as follows:

The wire which is coloured BLUE must be connected to the terminal which is marked with the letter N or coloured BLACK. The wire which is coloured BROWN must be connected to the terminal which is marked with the letter L or coloured RED.

Making sure that neither core is connected to the earth terminal of the three pin plug.

CONTENTS

INTRODUCTION

| | |
|--|----------|
| FEATURES | 2 |
| GETTING STARTED | 3 |
| Checking the Package Contents | 3 |
| Installing Batteries in the Remote Control | 3 |
| CONTROLS AND FUNCTIONS | 4 |
| Front Panel | 4 |
| Remote Control | 6 |
| Description of the Numeric Buttons | 7 |
| Using the Remote Control | 8 |
| Front Panel Display | 9 |
| Rear Panel | 10 |

PREPARATION

| | |
|---|-----------|
| SPEAKER SETUP | 11 |
| Speakers to Be Used | 11 |
| Speaker Placement | 11 |
| CONNECTIONS | 12 |
| Before Connecting Components | 12 |
| Connecting Audio Components | 12 |
| Connecting Video Components | 14 |
| Connecting the Speakers | 16 |
| Connecting an External Amplifier (Europe and U.K. models only) | 18 |
| Connecting an External Decoder | 18 |
| IMPEDANCE SELECTOR Switch | 19 |
| Connecting the Power Supply Cords | 19 |
| ON-SCREEN DISPLAY (OSD) | 20 |
| OSD Modes | 20 |
| Selecting the OSD Mode | 20 |
| SPEAKER MODE SETTINGS | 21 |
| Summary of SPEAKER SET Items 1A through 1E | 21 |
| ADJUSTING THE SPEAKER OUTPUT LEVELS | 22 |
| Before You Begin | 22 |
| Using the Test Tone (TEST DOLBY SUR.) | 22 |

BASIC OPERATION

| | |
|---------------------------------------|-----------|
| BASIC PLAYBACK | 24 |
| Input Modes and Indications | 26 |
| Selecting a Sound Field Program | 28 |
| Normal Stereo Reproduction | 29 |
| BASIC RECORDING | 30 |

ADVANCED OPERATION

| | |
|--|-----------|
| SET MENU | 31 |
| Adjusting the Items on the SET MENU | 31 |
| 1 SPEAKER SET (speaker mode settings) | 32 |
| 2 L/R BALANCE (balance of the left and right main speakers) | 34 |
| 3 HP TONE CTRL (headphone tone control) | 35 |
| 4 I/O ASSIGNMENT | 35 |
| 5 INPUT MODE (initial input mode) | 35 |
| 6 DOLBY D. SET (Dolby Digital set) | 36 |
| 7 DTS SET (DTS LFE level) | 36 |
| 8 SP DELAY TIME | 37 |
| 9 DISPLAY SET | 37 |
| 10 MEMORY GUARD | 37 |
| ADJUSTING THE LEVEL OF THE EFFECT SPEAKERS | 38 |
| SLEEP TIMER | 39 |
| Setting the Sleep Timer | 39 |
| Canceling the Sleep Timer | 39 |
| REMOTE CONTROL FEATURES | 40 |
| Selector Dial | 40 |
| Commonly Used Buttons in Any Position of the Selector Dial | 41 |
| Controlling the Components Connected to This Unit | 41 |
| Button Names and Functions in Each Position | 42 |
| Setting the Manufacturer Code | 45 |
| Returning to the Factory Setting | 46 |

ADDITIONAL INFORMATION

| | |
|--|-----------|
| SOUND FIELD PROGRAM | 47 |
| Hi-Fi DSP Programs | 47 |
| CINEMA DSP Programs | 47 |
| SOUND FIELD PROGRAM PARAMETER EDITING | 50 |
| What is a sound field? | 50 |
| Sound Field Program Parameters | 50 |
| Changing Parameter Settings | 51 |
| Resetting a Parameter to the Factory-set Value | 51 |
| Sound Field Parameter Descriptions | 52 |

APPENDIX

| | |
|------------------------------|-----------|
| TROUBLESHOOTING | 55 |
| SPECIFICATIONS | 59 |
| GLOSSARY | 60 |
| INDEX | 62 |

FEATURES

Built-in 5-Channel Power Amplifier

- ◆ Minimum RMS Output Power (0.06% THD, 20 Hz – 20 kHz)
Main: 90 W + 90 W (8 Ω)
Center: 90 W (8 Ω)
Rear: 90 W + 90 W (8 Ω)
- ◆ Maximum Power (EIAJ)
[China and General models only]
(10% THD, 1 kHz)
Main: 115 W + 115 W (8 Ω)
Center: 115 W (8 Ω)
Rear: 115 W + 115 W (8 Ω)

Multi-Mode Digital Sound Field Processing

- ◆ DTS Decoder
- ◆ Dolby Pro Logic Decoder
- ◆ Dolby Digital Decoder
- ◆ Hi-Fi DSP
- ◆ CINEMA DSP: Combination of YAMAHA DSP Technology and Dolby Pro Logic, Dolby Digital or DTS
- ◆ Virtual CINEMA DSP
- ◆ SILENT CINEMA

Other Features

- ◆ 96-kHz/24-bit D/A Converter
- ◆ “SET MENU” which Provides You with 10 Items for Optimizing This Unit for Your Audio/Video System
- ◆ Test Tone Generator for Easier Speaker Balance Adjustment
- ◆ 6-Channel External Decoder Input for Other Future Formats
- ◆ BASS EXTENSION Button for Reinforcing Bass Response
- ◆ On Screen Display Function Helpful in Controlling This Unit
- ◆ S Video Signal Input/Output Capability
- ◆ Component Video Input/Output Capability
- ◆ Optical and Coaxial Digital Audio Signal Jacks
- ◆ Sleep Timer
- ◆ Remote Control with Preset Manufacturer Codes

-  indicates a tip for your operation.
- Some operations can be performed by using either the buttons on the main unit or on the remote control. In cases when the button names differ between the main unit and the remote control, the button name on the remote control is given in parentheses in this manual.



Manufactured under license from Dolby Laboratories.

“Dolby”, “AC-3”, “Pro Logic” and the double-D symbol are trademarks of Dolby Laboratories.
Confidential Unpublished Works. ©1992-1997 Dolby Laboratories, Inc. All rights reserved.



Manufactured under license from Digital Theater Systems, Inc. US Pat. No. 5,451,942 and other world-wide patents issued and pending. “DTS” and “DTS Digital Surround” are trademarks of Digital Theater Systems, Inc. Copyright 1996 Digital Theater Systems, Inc. All Rights Reserved.

GETTING STARTED

Checking the Package Contents

Check your package to make sure it has the following items.

Remote control

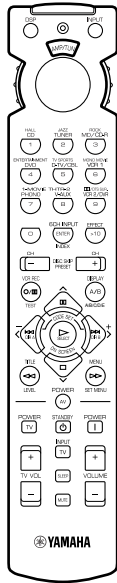

Batteries (4) (AAA, R03, UM-4)

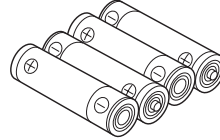

Quick Reference Card

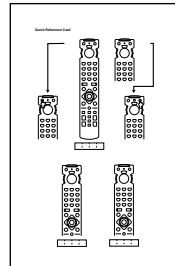

Connection guide

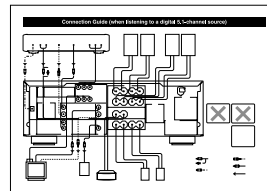

Installing Batteries in the Remote Control

Insert the batteries in the correct direction by aligning the + and – marks on the batteries with the polarity markings (+ and –) inside the battery compartment.

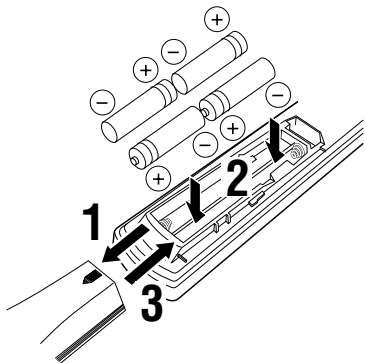

■ Notes on batteries

- Change the batteries periodically.
- Do not use old batteries together with new ones.
- Do not use different types of batteries (such as alkaline and manganese batteries) together. Read the packaging carefully as these different types of batteries may have the same shape and color.

■ Changing batteries

As the batteries lose power, the operating range of the remote control decreases and the indicator does not flash or its light becomes dim. When you notice any of these conditions, change all of the batteries.

If the remote control is without batteries for more than 2 minutes, or if exhausted batteries remain in the remote control, the contents of the memory may be cleared. When the memory is cleared, insert new batteries, set up the manufacturer code that may have been cleared.

Note

- If the batteries have leaked, dispose of them immediately. Avoid touching the leaked material or letting it come into contact with clothing, etc. Clean the battery compartment thoroughly before installing new batteries.

CONTROLS AND FUNCTIONS

Front Panel

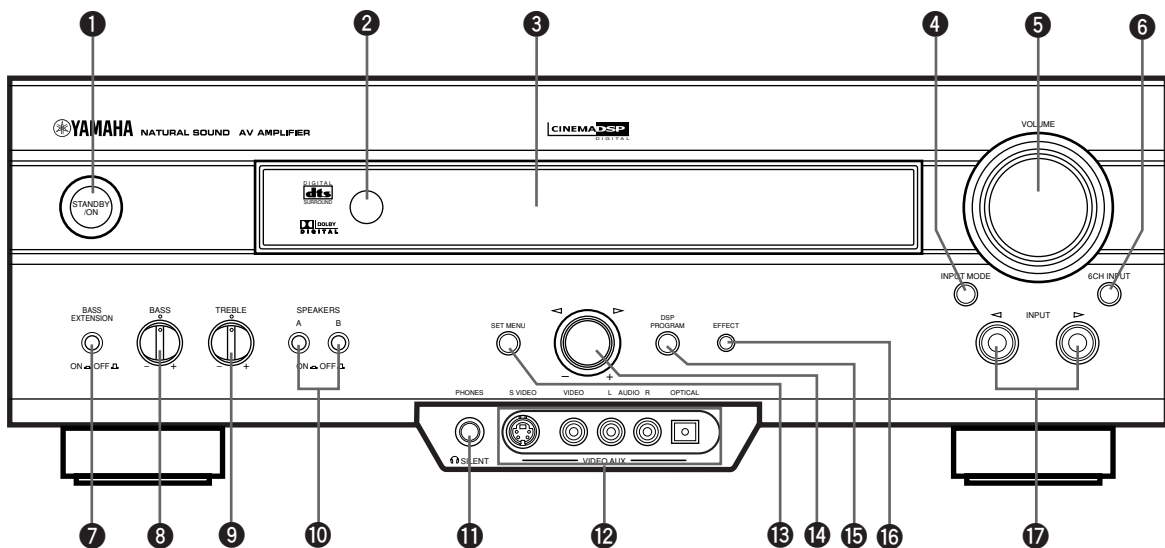

1 STANDBY/ON

Turns on or sets this unit in the standby mode. When you turn on this unit, you will hear a click and there will be a 4 to 5-second delay before this unit can reproduce sound.

Standby mode

In this mode, this unit consumes a small amount of power to receive infrared-signals from the remote control.

2 Remote control sensor

Receives signals from the remote control.

3 Front panel display

Shows information about the operational status of this unit.

4 INPUT MODE

Selects the mode of input for sources that send two or more types of signals to this unit (see page 26 for details). You cannot control the input mode when you select 6CH INPUT as the input source.

5 VOLUME

Controls the output level of all audio channels. This does not affect the REC OUT level.

6 6CH INPUT

Selects the source connected to the 6CH INPUT jacks. The source selected by pressing 6CH INPUT takes priority over the source selected with INPUT $\triangleleft/\triangleright$ (or the input selector buttons on the remote control).

7 BASS EXTENSION ON/OFF

When pushed in (ON), this feature boosts the bass frequency of the left and right main speakers by +6 dB (60 Hz) while maintaining overall tonal balance. This boost is useful if you do not use a subwoofer. However, this boost may not be noticeable if "1B MAIN SP" on the SET MENU is set to SMALL and "1D LFE/BASS OUT" is set to SWFR.

8 BASS

Adjusts the low-frequency response for the left and right main speakers.

Turn the control to the right to increase or to the left to decrease the low-frequency response.

9 TREBLE

Adjusts the high-frequency response for the left and right main speakers.

Turn the control to the right to increase or to the left to decrease the high-frequency response.

Note

- If you increase or decrease the high-frequency or the low-frequency sound to an extreme level, the tonal quality from the center and rear speakers may not match that of the left and right main speakers.

10 SPEAKERS A/B

When pushed in (ON), these buttons turn on the set of main speakers connected to the A and/or B terminals on the rear panel.

11 PHONES jack

Outputs audio signals for private listening with headphones. When you connect headphones, no signals are output to the speakers.



(Europe and U.K. models only)

- When you connect headphones, no signals are also output to the OUTPUT jacks.

12 VIDEO AUX jacks

Inputs audio and video signals from a portable external source such as a game console. To reproduce source signals from these jacks, select V-AUX as the input source.

13 SET MENU

Enters the SET MENU.

14 Multi jog knob

Selects and adjust the SET MENU item after pressing SET MENU.

Selects the DSP program after pressing DSP PROGRAM.

15 DSP PROGRAM

Switches the function of the multi jog knob for selecting DSP program.

16 EFFECT

Switches the effect speakers (center and rear) on and off.

If you turn off the output of these speakers by using EFFECT, all Dolby Digital and DTS audio signals except for the LFE channel are directed to the main left and right channels.

When Dolby Digital or DTS signals are mixed, the left and right main channel signal levels may not match.

17 INPUT ◀ / ▶

Selects the input source (CD, TUNER, MD/CD-R, DVD, D-TV/CBL, VCR 1, PHONO, V-AUX, VCR 2/DVR) you want to listen to or watch.

Remote Control

This section describes the basic operation of this unit with the remote control. First, set the selector dial to the AMP/TUN position. See “REMOTE CONTROL FEATURES” for full details.

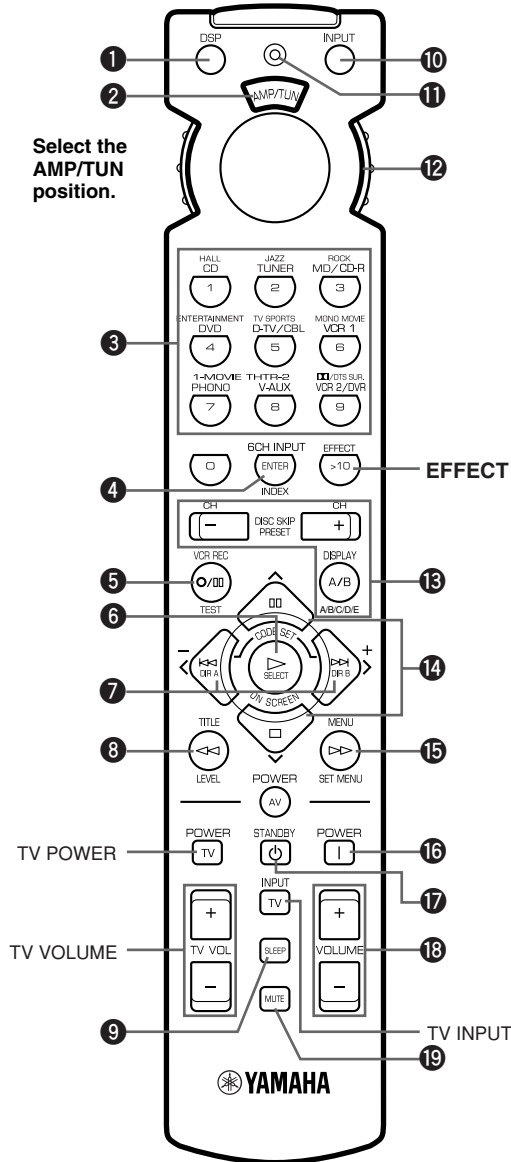

Select the AMP/TUN position.

- 1 DSP**
Switches the function of the numeric buttons to the DSP program selector.
- 2 Indicator window**
Shows the name of components which can be controlled.

- 3 Numeric buttons (Input selector buttons)**
These buttons select the input source.
See “Description of the Numeric Buttons” for the numeric buttons.
- 4 6CH INPUT**
Selects the source connected to the 6CH INPUT jacks.
- 5 TEST**
Outputs the test tone.
- 6 ON SCREEN**
Selects the on-screen display (OSD) mode for your video monitor.
- 7 </> (-/+)**
Adjust DSP program parameters and SET MENU items.
-/+ is displayed on the on-screen display.
- 8 LEVEL**
Selects the effect speaker channel (center, rear and subwoofer) so you can adjust their output level independently.
- 9 SLEEP**
Sets the sleep timer.
- 10 INPUT**
Switches the function of the numeric buttons to the input selector.
- 11 Indicator**
Flashes while the remote control is sending signals.
- 12 Selector dial**
Turn this dial to select the position for the component to be controlled. (The proper code must be set up for your component. See “Setting the Manufacture Codes”.) When a position is selected, the remote control is set to that component operation mode.
- 13 A/B/C/D/E, PRESET -/+**
These buttons are used to select a preset station when using YAMAHA tuner.
A/B/C/D/E: To select one of 5 preset station groups (A to E)
PRESET -/+ : To select a preset station number (1 to 8)
- 14 $\wedge \vee$**
Select DSP program parameters and SET MENU items.
- 15 SET MENU**
Enters the SET MENU.
- 16 POWER**
Turns on the power of this unit.
- 17 STANDBY**
Sets this unit in the standby mode.

18 VOLUME +/-

Increases or decreases the volume level.

19 MUTE

Mutes the sound. Press again to restore the audio output to the previous volume level.

EFFECT

Switches the effect speakers (center and rear) on and off in the following cases:

- When the selector dial is set to the DSP/TUN position.
- While the indicator is lit for about 3 seconds after pressing DSP.

Description of the Numeric Buttons

The numeric buttons function in various ways depending on the position of the selector dial or the combination of other instructions.

When selecting an input source

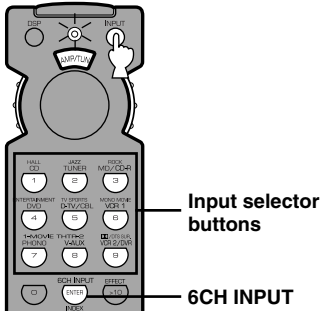

1 Press INPUT regardless of the position of the selector dial. The indicator lights up for about 3 seconds.

2 You can select an input source with the numeric buttons and 6CH INPUT while the indicator is lit.

When selecting a DSP program and turning on or off the effect speakers (center and rear)

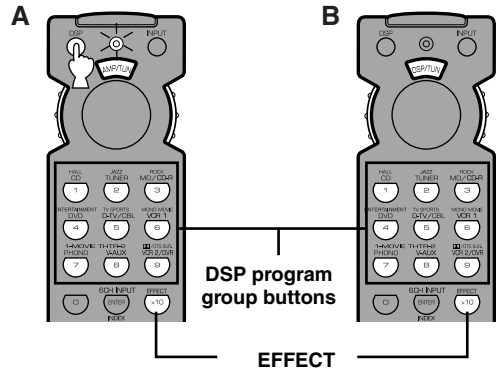

A

1 Press DSP regardless of the position of the selector dial. The indicator lights up for about 3 seconds.

2 You can select a DSP program with the numeric buttons and turn on or off the effect speakers (center and rear) by pressing EFFECT while the indicator is lit.

B

1 Set the selector dial to the DSP/TUN position.

2 You can select a DSP program directly with the numeric buttons and turn on or off the effect speakers (center and rear) by pressing EFFECT.

Using the Remote Control

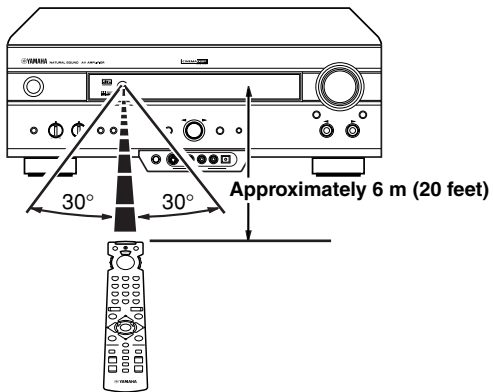

The remote control transmits a directional infrared beam. Be sure to aim the remote control directly at the remote control sensor on the main unit during operation.

■ Handling the remote control

- Do not spill water or other liquids on the remote control.
- Do not drop the remote control.
- Do not leave or store the remote control in the following types of conditions:
 - high humidity or temperature such as near a heater, stove or bath;
 - dusty places; or
 - in places subject to extremely low temperatures.

Front Panel Display

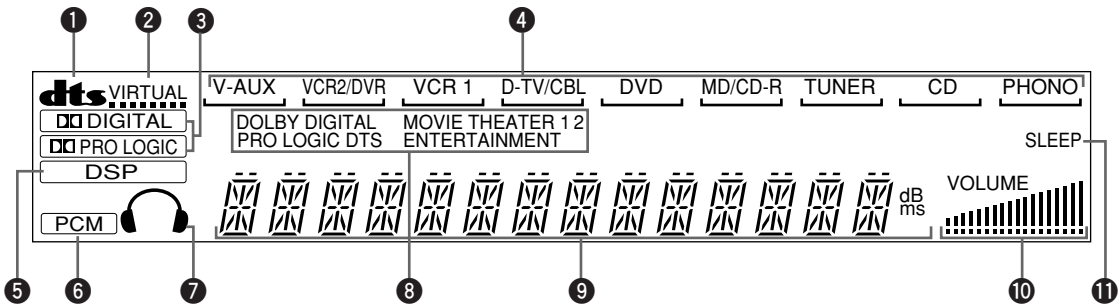

1 **dts** indicator

Lights up when the built-in DTS decoder is on.

2 **VIRTUAL** indicator

Lights up when using Virtual CINEMA DSP.

3 **DIGITAL** and **PRO LOGIC** indicators

Light up according to the type of Dolby signals this unit is reproducing. “**DIGITAL**” lights up when the built-in Dolby Digital decoder is on. “**PRO LOGIC**” lights up when the built-in Dolby Pro Logic decoder is on.

4 **Input source** indicator

Shows the current input source with a cursor.

5 **DSP** indicator

Lights up when you select a DSP program.

6 **PCM** indicator

Lights up when this unit is reproducing PCM (pulse code modulation) digital audio signals.

7 **Headphones** indicator

Lights up when headphones are connected.

8 **DSP program** indicators

The name of the selected DSP program lights up when the ENTERTAINMENT, MOVIE THEATER 1, MOVIE THEATER 2 or **DIGITAL**/DTS SURROUND DSP program is selected.

9 **Multi-information** display

Shows the current DSP program name and other information when adjusting or changing settings.

10 **VOLUME** level indicator

Indicates the volume level.

11 **SLEEP** indicator

Lights up while the sleep timer is on.

Rear Panel

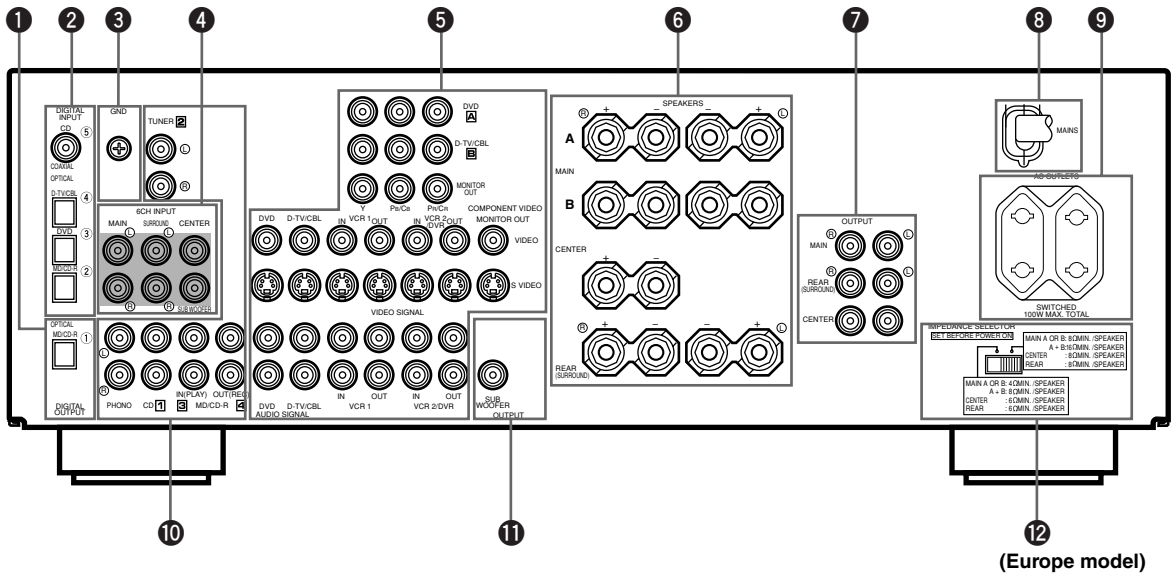

1 DIGITAL OUTPUT jacks

2 DIGITAL INPUT jacks

3 GND terminal

See page 12 for connection information.

4 6CH INPUT jacks

See page 18 for connection information.

5 Video component jacks

See pages 14 and 15 for connection information.

6 Speaker terminals

See pages 16 and 17 for connection information.

7 OUTPUT jacks (Europe and U.K. models only)

See page 18 for connection information.

8 AC power cord

Connect to a power outlet.

9 AC OUTLET(S)

Use these outlets to supply power to your other audio/video components (see page 19).

10 Audio component jacks

See pages 12 and 13 for connection information.

11 SUBWOOFER jack

See page 17 for connection information.

12 IMPEDANCE SELECTOR switch

Use this switch to match the amplifier output to your speaker impedance. Set this unit in the standby mode before you change the setting of this switch (see page 19).

China and General models only

VOLTAGE SELECTOR

See page 19.

SPEAKER SETUP

Speakers to Be Used

This unit has been designed to provide the best sound-field quality with a 5-speaker system, using left and right main speakers, left and right rear speakers, and a center speaker. If you use different brands of speakers (with different tonal qualities) in your system, the tone of a moving human voice and other types of sound may not shift smoothly. We recommend that you use speakers from the same manufacturer to ensure even tonal quality.

The main speakers are used for the main source sound plus the effect sounds. They will probably be the speakers from your present stereo system. The rear speakers are used for the effect and surround sounds, and the center speaker is for the center sounds (dialog, vocals, etc.). If for some reason it is not practical to use a center speaker, you can do without it. Best results, however, are obtained with the full system.

The main speakers should be high-performance models and have enough power-handling capacity to accept the maximum output of your audio system. The other speakers do not have to be equal to the main speakers. For precise sound localization, however, it is ideal to use high-performance models that can reproduce sounds over the full range for the center speaker and the rear speakers.

■ Use of a subwoofer expands your sound field

It is also possible to further expand your system with the addition of a subwoofer. The use of a subwoofer is effective not only for reinforcing bass frequencies from any or all channels, but also for reproducing the LFE (low-frequency effect) channel with high fidelity when the Dolby Digital signal or the DTS signal is played back. The YAMAHA Active Servo Processing Subwoofer System is ideal for natural and lively bass reproduction.

Speaker Placement

Refer to the following diagram when you place the speakers.

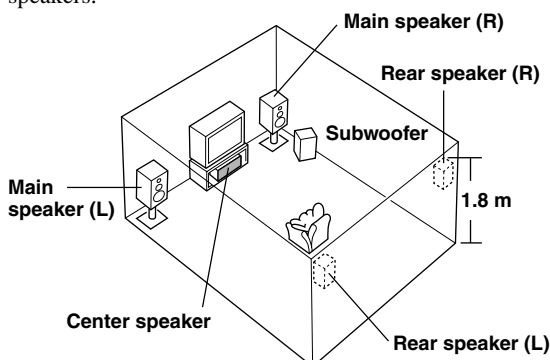

■ Main speakers

Place the left and right main speakers an equal distance from the ideal listening position. The distance of each speaker from each side of the video monitor should be the same.

■ Rear speakers

Place these speakers behind your listening position, facing slightly inwards, nearly 1.8 m (approx. 6 feet) above the floor.

■ Center speaker

Align the front face of the center speaker with the front face of your video monitor. Place the speaker as close to the monitor as possible, such as directly over or under the monitor and centrally between the main speakers.

Note

- If the center speaker is not used, the center channel sound will be heard from the left and right main speakers. In this case, "1A CENTER SP" on the SET MENU is set to NONE.

■ Subwoofer

The position of the subwoofer is not so critical, because low bass sounds are not highly directional. But it is better to place the subwoofer near the main speakers. Turn it slightly toward the center of the room to reduce the wall reflections.

CAUTION

Please use magnetically shielded speakers. Sometimes a video monitor may be adversely affected even when magnetically shielded speakers are used. Separate the speakers from the monitor if this happens.

CONNECTIONS

Before Connecting Components

CAUTION

Never connect this unit and other components to mains power until all connections between components have been completed.

- Be sure all connections are made correctly, that is to say L (left) to L, R (right) to R, “+” to “+” and “-” to “-”. Some components require different connection methods and have different jack names. Refer to the operation instructions for each component to be connected to this unit.
- When you connect other YAMAHA audio components (such as a tape deck, MD recorder and CD player or changer), connect them to the jack with the same number labels as 1, 2, 3 etc.
- After you have completed all connections, check them again to make sure they are correct.

Connecting Audio Components

■ Connecting to digital jacks

This unit has digital jacks for direct transmission of digital signals through either coaxial or fiber optic cables. You can use the digital jacks to input PCM, Dolby Digital and DTS bitstreams. When you connect components to both the COAXIAL and OPTICAL jacks, priority is given to the input signals from the COAXIAL jack. All digital input jacks are acceptable for 96-kHz sampling digital signals.



- You can designate the input for each digital jack according to your component by using “4 I/O ASSIGNMENT” on the SET MENU.

About the dust protection cap

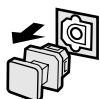

Pull out the cap from the optical jack before you connect the fiber optic cable. Do not discard the cap. When you are not using the optical jack, be sure to put the cap back in place. This cap protects the jack from dust.

Note

- The OPTICAL jacks on this unit conform to the EIA standard. If you use a fiber optic cable that does not conform to this standard, this unit may not function properly.

■ Connecting a turntable

PHONO jacks are for connecting a turntable with an MM or high-output MC cartridge. If you have a turntable with a low-output MC cartridge, use an inline boosting transformer or MC-head amplifier when connecting to these jacks.



- The GND terminal does not electrically ground the turntable. It simply reduces noise in the signal. In some cases, you may hear less noise if you do not connect to the GND terminal.

■ Connecting a tuner

You can listen to an FM or AM broadcasting by connecting AM/FM tuner.

To get clearer reception, connect the antennas correctly. Refer to your tuner’s operation instructions for details.

■ Connecting a CD player



- The COAXIAL jack is available for a CD player which has a coaxial digital output jack.
- When you connect a CD player to both the analog and digital jacks, priority is given to the input signals from the digital jack.

■ Connecting an MD recorder, CD recorder or tape deck



- When you connect your recording component to both the analog and digital input and output jacks, the priority is given to the digital signal.

Notes

- When you connect a recording component to this unit, keep its power on while using this unit. If the power is off, this unit may distort the sound from other components.
- Since digital output and analog output (REC OUT) are independent of each other, the analog signal is output only to the analog jack, while the digital signal is output only to the digital jack.

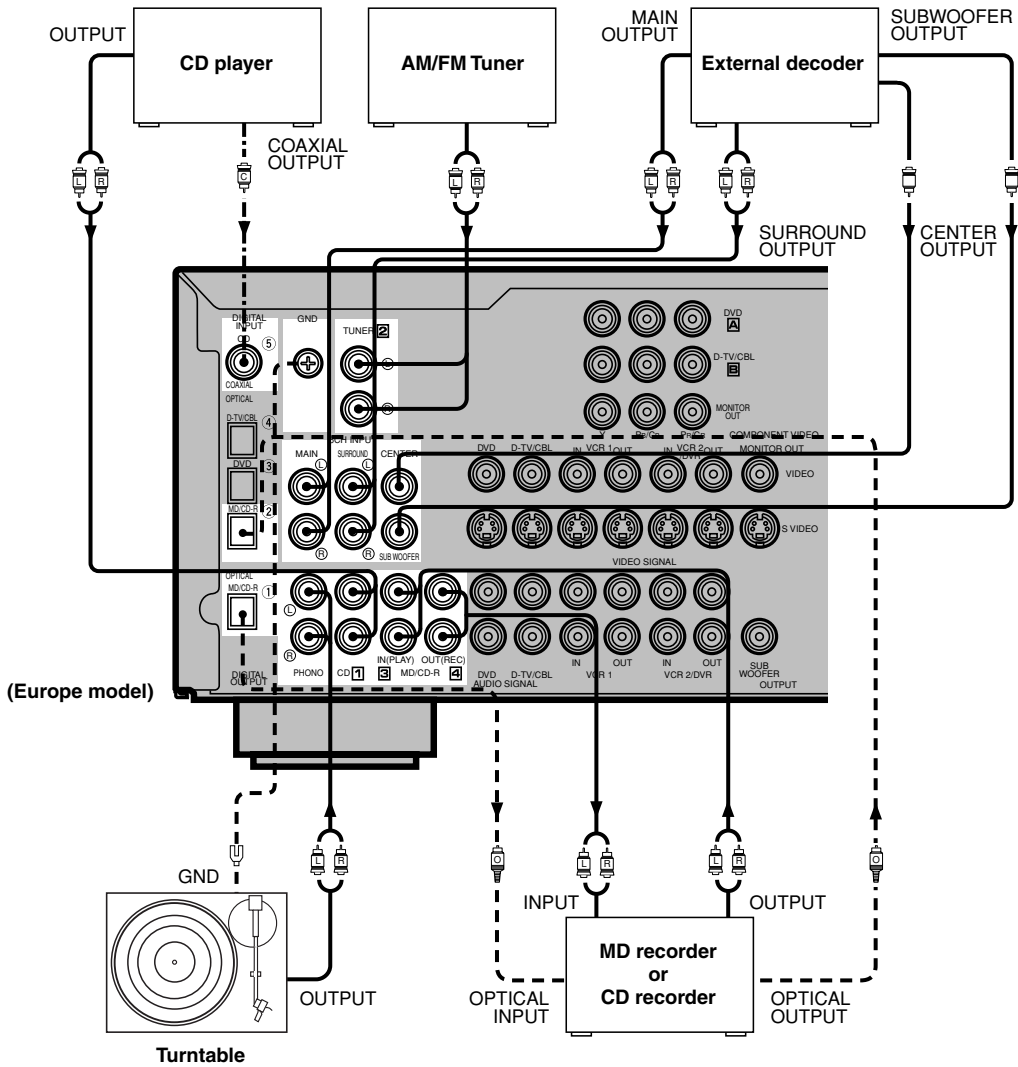

- ▶ indicates signal direction
- |◁ indicates left analog cables
- |▷ indicates right analog cables
- - -|◁ indicates optical cables
- - -|▷ indicates coaxial cables

Connecting Video Components

About the video jacks

There are three types of video jacks. Video signals input through the VIDEO jacks are the conventional composite video signals. Video signals input through the S VIDEO jacks are separated into luminance (Y) and color (C) video signals. The S-video signals achieve high-quality color reproduction. Video signals input through the COMPONENT VIDEO jacks are separated into luminance (Y) and color difference (P_B/C_B, P_R/C_R) video signals. The jacks are also separated into three for each signal. The description of the component video jacks may be different depending on the component (e.g. Y, C_B, C_R/Y, P_B, P_R/Y, B-Y, R-Y etc.). Component video signals provide the best quality in picture reproduction.

If your video component has an S-video output or component video output, you can connect it to this unit. Connect the S-video signal output jack on your video component to the S VIDEO jack or connect the component signal output jacks on your video component to the COMPONENT VIDEO jacks.



VIDEO jack (composite)



S VIDEO jack



COMPONENT VIDEO jacks



- Each type of video jack works independently. Signals input through the composite video, S-video and component jacks are output through the corresponding composite video, S-video, and component jacks, respectively.
- If you make S-video connections to this unit, it is not necessary to make composite video connections. If both types of connections are made, this unit gives priority to the S-video signal.
- You can designate the input for the COMPONENT VIDEO A and B jacks according to your component by using "4 I/O ASSIGNMENT" on the SET MENU.

Notes

- Use a commercially available S-video cable when connecting to the S VIDEO jack, and commercially available video cables when connecting to the COMPONENT VIDEO jacks.
- When you are using the COMPONENT VIDEO jacks, check the details in the owner's manual that came with the component being connected.

Video monitor with a 21-pin connector (Europe and U.K. models only)

Make a connection as shown on page 15 with a commercially available SCART-plug connector cable.

VIDEO AUX jacks (on the front panel)

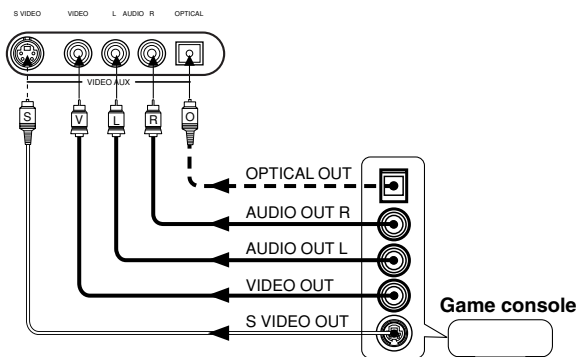

These jacks are used to connect any video input source such as a game console to this unit.

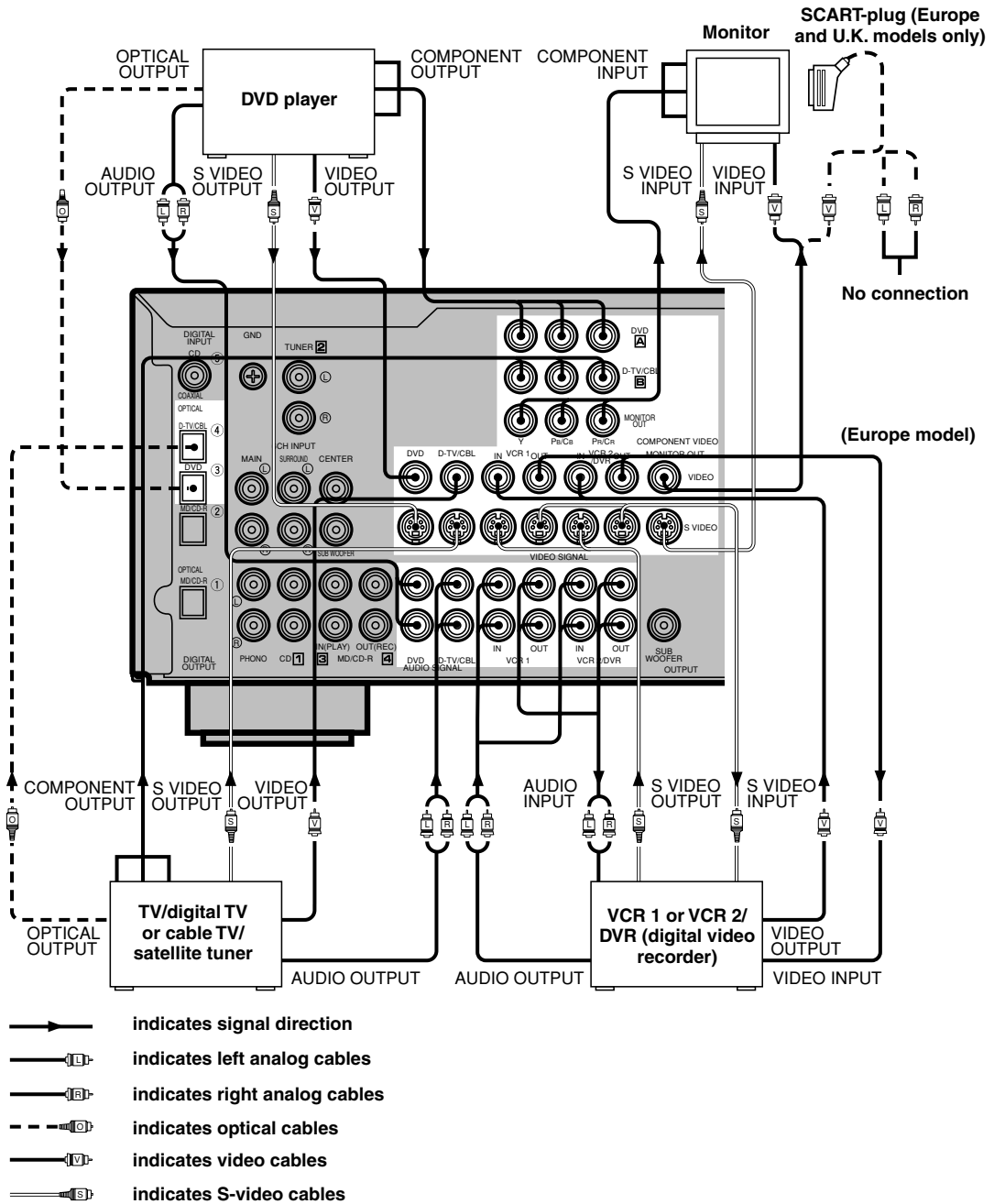

When using an LD player

Connect the LD player output to the DVD jack.

If the LD player has an OPTICAL digital output jack, connect it to this unit's OPTICAL DVD jack. If it has analog jacks, connect it to the analog DVD jacks. If it has an "RF OUTPUT jack" to output a Dolby Digital RF signal (AC-3), use a commercially available RF demodulator and connect it to the OPTICAL DVD jack.

If connecting a DVD player and an LD player, connect the LD player to the digital input jack (ex. D-TV/CBL) or to the analog input jack (D-TV/CBL, VCR 1 or VCR 2/DVR). For details on connections and operations, refer to the operation instructions for the LD player.

Note that this unit's remote control can be used to operate the LD player by setting the corresponding manufacturer code for the DVD/LD position.

Connecting the Speakers

Be sure to connect the left channel (L), right channel (R), “+” (red) and “-” (black) properly. If the connections are faulty, no sound will be heard from the speakers, and if the polarity of the speaker connections is incorrect, the sound will be unnatural and lack bass.

CAUTION

- Use speakers with the specified impedance shown on the rear panel of this unit.
- Do not let the bare speaker wires touch each other and do not let them touch any metal part of this unit. This could damage the unit and/or speakers.

If necessary, use the SET MENU to change the speaker mode settings according to the number and size of the speakers in your configuration after you finish connecting your speakers.

■ Speaker cables

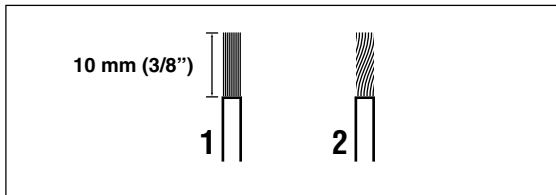

A speaker cord is actually a pair of insulated cables running side by side. One of the cables is colored or shaped differently, perhaps with a stripe, groove or ridge.

- 1 Remove approx. 10 mm (3/8") of insulation from each of the speaker cables.**
- 2 Twist the exposed wires of the cable together to prevent short circuits.**

■ Connecting to the SPEAKERS terminals

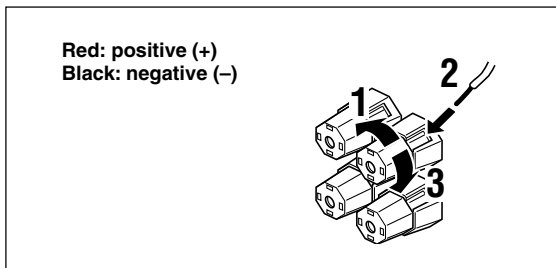

- 1 Unscrew the knob.**
- 2 Insert one bare wire into the hole in the side of each terminal.**
- 3 Tighten the knob to secure the wire.**

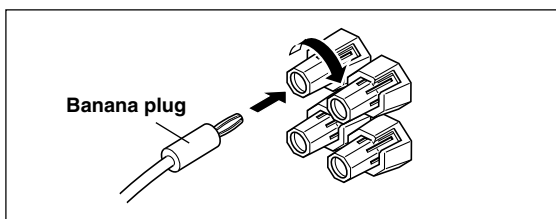

(China and General models only)

- Banana plug connections are also possible. First, tighten the knob and then insert the banana plug connector into the end of the corresponding terminal.

■ MAIN SPEAKERS terminals

One or two speaker systems can be connected to these terminals. If you use only one speaker system, connect it to either of the MAIN A or B terminals.

■ REAR SPEAKERS terminals

A rear speaker system can be connected to these terminals.

■ CENTER SPEAKER terminals

A center speaker can be connected to these terminals.

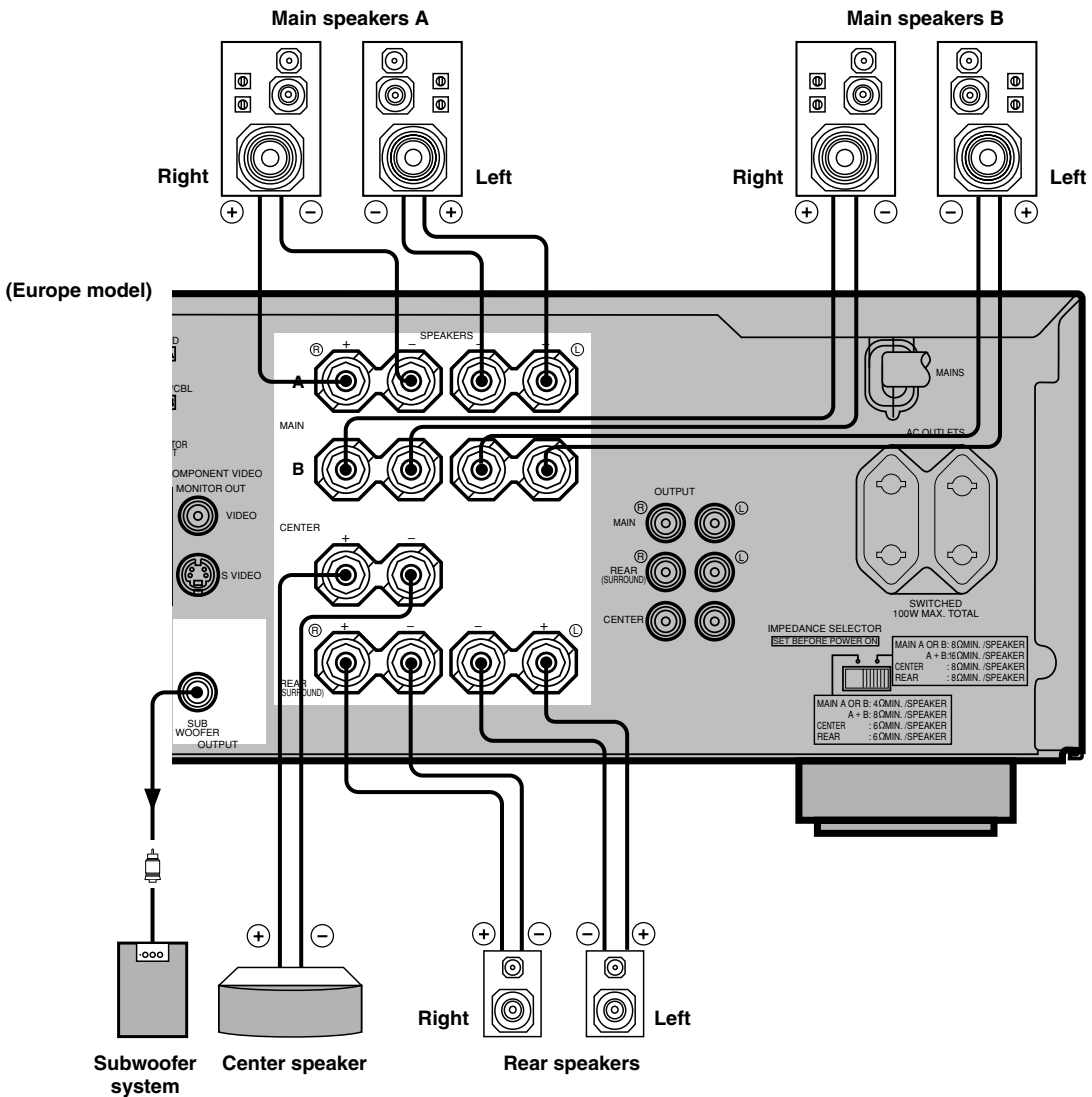

PREPARATION

■ SUBWOOFER jack

When using a subwoofer with built-in amplifier, including the YAMAHA Active Servo Processing Subwoofer System, connect the input jack of the subwoofer system to this jack. Low bass signals distributed from the main, center and/or rear channels are directed to this jack. (The cut-off frequency of this jack is 90 Hz.) The LFE (low-frequency effect) signals generated when Dolby Digital or DTS is decoded are also directed if they are assigned to this jack.

Notes

- Adjust the subwoofer volume according to the operating instructions for the subwoofer. (Fine adjustment is possible using this unit's output level control of the effect speakers.)
- Depending on the settings of "1 SPEAKER SET", "6 DOLBY D. SET" and "7 DTS SET" on the SET MENU, some signals may not be output from the SUBWOOFER jack.

English

Connecting an External Amplifier (Europe and U.K. models only)

If you want to increase the power output to the speakers, or want to use another amplifier, connect an external amplifier to the OUTPUT jacks as follows.

Note

- When RCA pin plugs are connected to the OUTPUT jacks for output to an external amplifier, do not use the corresponding SPEAKERS terminals.

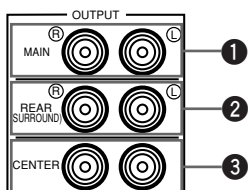

1 MAIN jacks

Main channel line output jacks.

Note

- The signals output through these jacks are affected by the BASS, TREBLE and BASS EXTENSION settings.

2 REAR (SURROUND) jacks

Rear channel line output jacks.

3 CENTER jacks

Center channel line output jacks.

Connecting an External Decoder

This unit is equipped with 6 additional input jacks (left and right MAIN, CENTER, left and right SURROUND and SUBWOOFER) for discrete multi-channel input from an external decoder, sound processor or pre-amplifier.

Connect the output jacks on your external decoder to the 6CH INPUT jacks. Be sure to match the left and right outputs to the left and right input jacks for the main and surround channels.

Notes

- When you select 6CH INPUT as the input source, this unit automatically turns off the digital sound field processor, and you cannot listen to DSP programs.
- When you select 6CH INPUT as the input source, changing items 1A to 1E on the SET MENU is not affected.

IMPEDANCE SELECTOR Switch

WARNING

Do not change the IMPEDANCE SELECTOR switch setting while the power of this unit is on, otherwise the unit may be damaged.
 If this unit fails to turn on when STANDBY/ON (or POWER) is pressed, the IMPEDANCE SELECTOR switch may not be fully slid to either position. If so, slide the switch to either position fully when this unit is in the standby mode.

Select the left or right position according to the impedance of the speakers in your system. Be sure to move this switch only when this unit is in the standby mode.

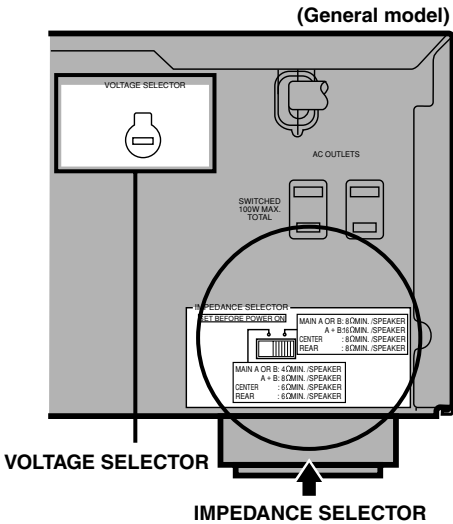

| Switch position | Speaker | Impedance level |
|-----------------|---------|---|
| Left | Main | If you use one set of main speakers, the impedance of each speaker must be 4 Ω or higher. |
| | | If you use two sets of main speakers, the impedance of each speaker must be 8 Ω or higher. |
| | Rear | The impedance of each speaker must be 6 Ω or higher. |
| Right | Main | If you use one set of main speakers, the impedance of each speaker must be 8 Ω or higher. |
| | | If you use two sets of main speakers, the impedance of each speaker must be 16 Ω or higher. |
| | Rear | The impedance of each speaker must be 8 Ω or higher. |

PREPARATION

VOLTAGE SELECTOR (China and General models only)

The VOLTAGE SELECTOR on the rear panel of this unit must be set for your local main voltage BEFORE plugging into the AC main supply. Voltages are 110/120/220/240 V AC, 50/60 Hz.

Connecting the Power Supply Cords

After completing all connections, connect the AC power cord to an AC power outlet. Disconnect the AC power cord if you will not use this unit for a long period of time.

AC OUTLET(S) (SWITCHED)

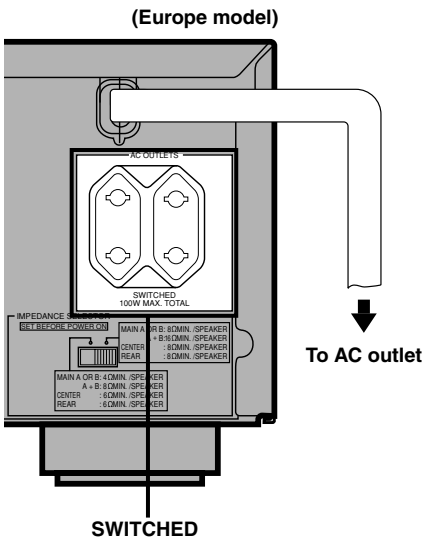

Europe, China and General models 2 OUTLETS
 U.K. model 1 OUTLET
 Use these outlets to connect the power cords only from your audio/video components to this unit. The power to the AC OUTLET(S) is controlled by this unit's STANDBY/ON (or POWER and STANDBY). These outlets will supply power to any connected component whenever this unit is turned on. The maximum power (total power consumption of components) that can be connected to the AC OUTLET(S) is 100 W.

English

ON-SCREEN DISPLAY (OSD)

You can display the operation information for this unit on a video monitor. If you display the SET MENU and DSP program parameter settings on a monitor, it is much easier to see the available options and parameters than it is by reading this information on the front panel display.



- If a video source is being reproduced, the OSD is superimposed over the image.
- The OSD signal is not output to the REC OUT jack, and will not be recorded with any video signal.
- You can set the OSD to turn on (blue background) or off when a video source is not being reproduced (or the source component is turned off) by using “9 DISPLAY SET” on the SET MENU.

OSD Modes

You can change the amount of information the OSD shows.

Full display

This mode always shows the DSP program parameter settings on the video monitor.

Short display

This mode briefly shows the same contents as the front panel display at the bottom of the screen and then disappears.

Display off

This mode briefly shows the “DISPLAY OFF” message at the bottom of the screen and then disappears. Afterwards, no changes to operations appear on the monitor except those of the ON SCREEN button.

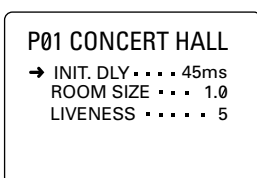

Full display

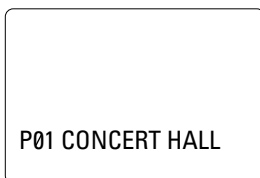

Short display



- When you choose the full display mode, INPUT </>, VOLUME and some other types of operation information are displayed at the bottom of the screen in the same format as that for the front panel display.
- The SET MENU and test tone display appear regardless of the OSD mode.

Selecting the OSD Mode

1 When you turn on the power, the video monitor and front panel display show the level of the main volume for a few seconds and then switch to show the current DSP program.

2 Press ON SCREEN on the remote control repeatedly to change the display mode.

The OSD mode changes in the following order: full display, short display, and display off.

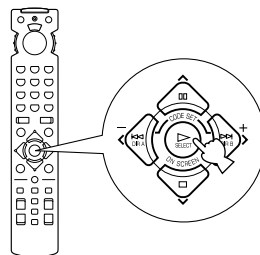

Notes

- If you choose a video input source that has a component connected to both the S VIDEO IN and composite VIDEO IN jacks, and both the S VIDEO OUT and composite VIDEO OUT jacks are connected to a video monitor, the video signal is output to both the S VIDEO OUT and VIDEO OUT jacks. However, the OSD is carried only on the S-video signal. If no video signal is input, the OSD is carried on both the S-video and composite video signals.
- If your video monitor is connected only to the COMPONENT VIDEO jacks of this unit, the OSD is not shown. Make sure to connect your video monitor to the COMPONENT VIDEO jacks and either VIDEO or S VIDEO jacks if you want to see the OSD.
- Playing back video software that has an anti-copy signal or video signals with a lot of noise may produce unstable images.

SPEAKER MODE SETTINGS

This unit is equipped with a main amplifier capable of handling 5.1 channel. Although up to 6 speakers can be connected, it is possible to select the speaker mode that gives the best sound field effect according to the number and size of speakers being used.

Before use, please set the speaker mode setting using “1 SPEAKER SET” on the SET MENU described on page 32.

Summary of SPEAKER SET Items 1A through 1E

| Item | Description | Control value (default setting indicated in bold) |
|------------------------|---|---|
| 1A CENTER SP | Selects the output mode according to whether or not a center speaker is being used and its performance. | LRG /SML/NONE |
| 1B MAIN SP | Selects the output mode according to the performance of the main speakers. | LARGE /SMALL |
| 1C REAR L/R SP | Selects the output mode according to whether or not rear L/R speakers are being used and their performance. | LRG /SML/NONE |
| 1D LFE/BASS OUT | Selects the speaker according to use for LFE signal output and low bass signal. | SWFR/ MAIN / BOTH |
| 1E MAIN LEVEL | Selects the main speaker level. | Normal /-10 dB |

ADJUSTING THE SPEAKER OUTPUT LEVELS

This section explains how to adjust the speaker output levels by using the test tone generator. When this adjustment is made, the output level heard at the listening position will be the same from each speaker. This is important for the best performance of the digital sound field processor, the Dolby Pro Logic decoder, Dolby Digital decoder and DTS decoder.

Note

- Since this unit cannot enter the test mode while headphones are connected to this unit, be sure to unplug the headphones from the PHONES jack when using the test tone.

Before You Begin

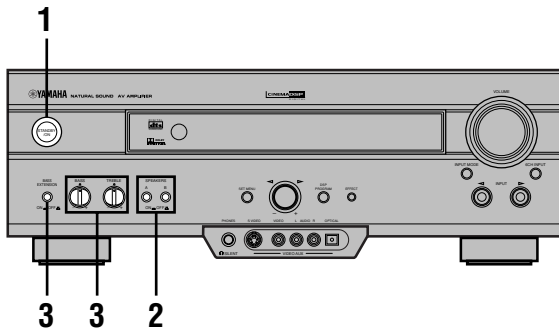

- 1 Press **STANDBY/ON** to turn on the power. Turn on the video monitor.



- 2 Press **SPEAKERS A or B** to select the main speakers to be used.

If you are using two sets of the main speakers, press both A and B.

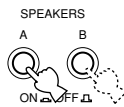

- 3 Set **BASS** and **TREBLE** on the front panel to the center position and set **BASS EXTENSION** to OFF.

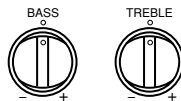

Using the Test Tone (TEST DOLBY SUR.)

The adjustment of each speaker output level should be made at your listening position with the remote control.

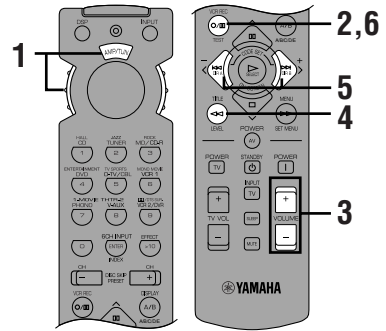

- 1 Set the selector dial to the **AMP/TUN** (or **DSP/TUN**) position.



- 2 Press **TEST** to output the test tone.



- 3 Adjust the volume so you can hear the test tone.

The test tone is heard from the left main speaker, center speaker, right main speaker, right rear speaker and left rear speaker in order. The tone is produced for 2.5 seconds each time.

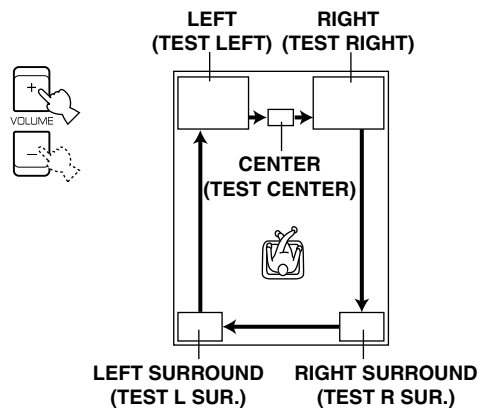

The state of the test tone output is also shown on the monitor by an image of the audio listening room. This is convenient for adjusting each speaker level.

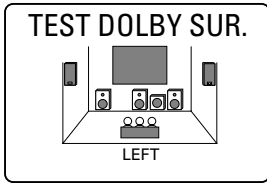

- If “1A CENTER SP” on the SET MENU is set to NONE, the center channel sound is automatically output from the left and right main speakers.

Note

- If the test tone cannot be heard, turn down the volume, set the unit in the standby mode and check the speaker connections.

4 Press LEVEL repeatedly to select the speaker to be adjusted.



- Once you press LEVEL, you can also select the speaker to be adjusted by pressing ∨. (Pressing ∧ changes the selection in the reverse order.)

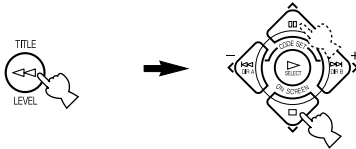

5 Press </> repeatedly to adjust the output level of the currently selected speaker so that it becomes almost the same as that of the main speaker.

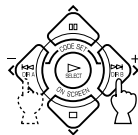

- While adjusting, the test tone is heard from the selected speaker.
- Repeat steps 4 and 5 to adjust the output levels of the center, left rear and right rear speakers.

6 When the adjustment is complete, press TEST.

The test tone stops and the current DSP program appears on the front panel display and on the video monitor.



Notes

- For details on adjusting the subwoofer speaker, refer to the effect speaker level adjustment described on page 38.
- After adjusting with the test tone, it is possible to adjust the speaker level to taste while listening to the playback of an actual source when using the effect speaker level adjustment described on page 38.



- You can increase the output levels of the effect speakers (center, left rear and right rear) to +10 dB. If the output level of these speakers is lower than that of the main speakers even after you have increased the output level of these speakers up to +10 dB, set “1E MAIN LEVEL” on the SET MENU to -10 dB. This setting decreases the main speaker output level to about one-third of the normal level. After you have set “1E MAIN LEVEL” on the SET MENU to -10 dB, adjust the levels for the center and rear speakers again.

BASIC PLAYBACK

When using the remote control, set the selector dial to the AMP/TUN position.

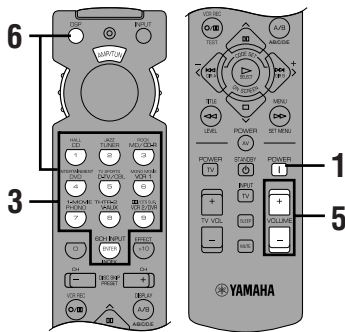
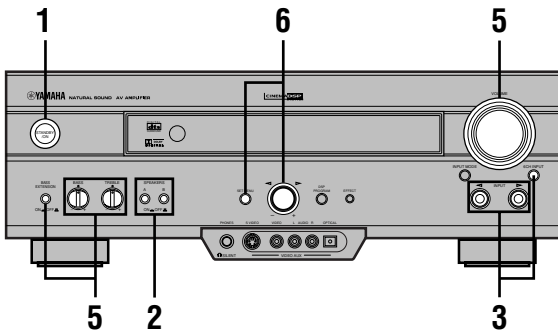

1 Press STANDBY/ON (or POWER) to turn on the power. Turn on the video monitor.

The front panel display and the video monitor show the level of the main volume for a few seconds and then switch to show the current DSP program.

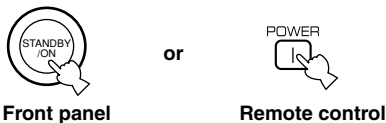

2 Press SPEAKERS A or B to select the main speakers to be used.

If you are using two sets of main speakers, press both A and B.

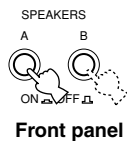

3 Press INPUT </> repeatedly (or press one of the input selector buttons) to select the input source.

- The current input source is indicated on the front panel display with a cursor.
- The current input source name and input mode appear on the front panel display and on the video monitor for a few seconds.

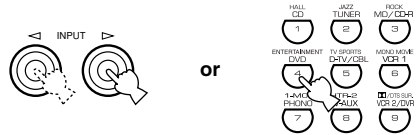

Front panel

Remote control

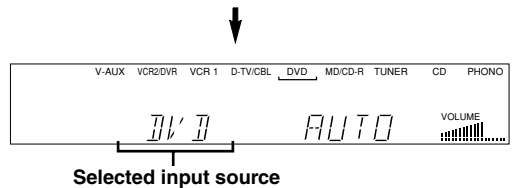

| Select this: | To reproduce the signal from this component |
|--------------|---|
| PHONO: | Turntable |
| CD: | CD player |
| TUNER: | AM/FM tuner |
| MD/CD-R: | MD recorder/CD recorder/tape deck |
| DVD: | DVD player |
| D-TV/CBL: | TV/digital TV or cable TV/satellite tuner |
| VCR 1: | Video cassette deck 1 |
| VCR 2/DVR: | Video cassette deck 2/digital video recorder |
| V-AUX: | Another audio/video component (connected to the VIDEO AUX jacks on the front panel) |

To select a source connected to the 6CH INPUT jacks

Press 6CH INPUT until “6CH INPUT” appears on the front panel display and on the video monitor.

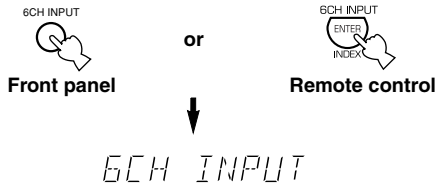

Notes

- If “6CH INPUT” is shown on the front panel display and on the video monitor, no other source can be played. To select another input source with INPUT </> (or the input selector buttons), press 6CH INPUT to turn off “6CH INPUT” from the front panel display and the video monitor.
- If you want to enjoy an audio source connected to the 6CH INPUT jacks together with a video source, first select the video source and then press 6CH INPUT.

4 Start playback (or select a broadcast station) on the source component.

Refer to the operation instructions for the component.

5 Adjust the volume to the desired output level.

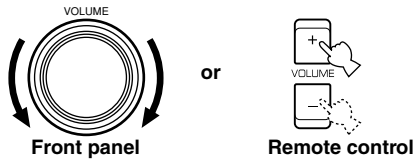

If desired, use BASS, TREBLE and BASS EXTENSION etc. These controls are only effective for sound from the main speakers.

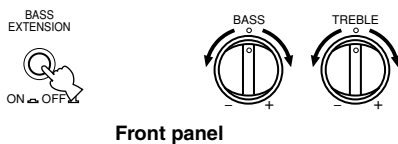

Note

- If the component connected to the VCR 1 OUT, VCR 2/DVR OUT and MD/CD-R OUT jacks is turned off, the reproduced sound may be distorted or the volume may be lowered. In these cases, turn on the component.

6 Use the digital sound field processor.

See “Selecting a Sound Field Program”.

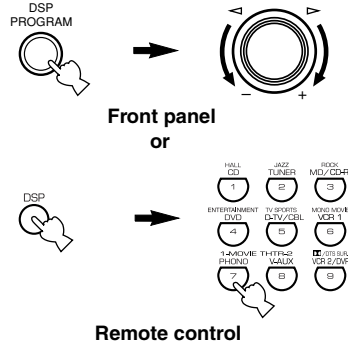

To mute the sound

Use this when you want to temporarily mute audio output.

Press MUTE on the remote control.



To restore the audio output to the previous volume level, press MUTE again.



- You can also cancel mute to press any operation buttons such as VOLUME +/-.
- During muting, “MUTE ON” appears on the front panel display and on the video monitor.

When you have finished using this unit

Press STANDBY/ON (or STANDBY) to set this unit in the standby mode.

Notes on the digital signal

The digital input jacks of this unit can also handle 96-kHz sampling digital signals. (To utilize this, use a source that supports 96-kHz sampling digital signals and set the player for digital output. Refer to the operation instructions for the player.) Note the following when a 96-kHz sampling digital signal is input to this unit:

1. The following indication will appear on the front panel display.

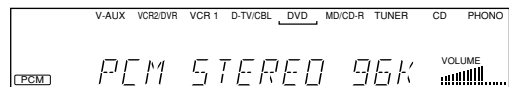

2. DSP programs cannot be selected. Sound will be output as normal 2-channel stereo sound from only the left and right main speakers.

Note

- If “1B MAIN SP” on the SET MENU is set to SMALL and “1D LFE/BASS OUT” is set to SWFR, or “1D LFE/BASS OUT” is set to BOTH, the sound is also output from the subwoofer.
3. Adjustment of the speaker output level described on page 38 cannot be made.

■ BGV (background video) function

The BGV function allows you to combine a video image from a video source with a sound from an audio source. (For example, you can listen to classical music while you are watching a video.)

Select a source from the video group and then select a source from the audio group with the input selector buttons on the remote control. The BGV function does not work if you select the sources with INPUT ◀/▶ on the front panel.

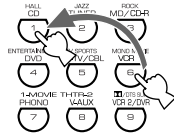

Input Modes and Indications

When using the remote control, set the selector dial to the AMP/TUN position.

This unit comes with various input jacks. If your component is connected to more than one type of input jack, you can set the priority of the input signal.

Press INPUT MODE (or the input selector button that you have pressed to select the input source on the remote control) repeatedly until the desired input mode is shown on the front panel display and on the video monitor.

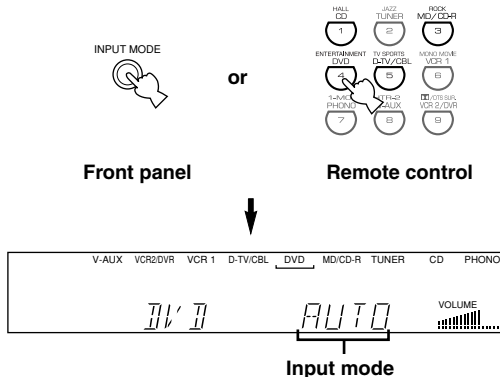

AUTO:

In this mode, the input signal is automatically selected in the following order:

- 1) Dolby Digital or DTS signal
- 2) Digital (PCM) signal
- 3) Analog signal

DTS:

In this mode, only the digital input signal encoded with DTS is selected even if another signal is input at the same time.

ANLG (ANALOG): In this mode, only the analog input signal is selected even if a digital signal is input at the same time.

Notes

- If digital signals are input from both the COAXIAL and OPTICAL jacks, the digital signal from the COAXIAL jack is selected.
- When AUTO is selected, this unit automatically determines the type of signal. If this unit detects a Dolby Digital or DTS signal, the decoder automatically switches to the appropriate setting and reproduces 5.1 channel source.
- The sound output may be interrupted for some LD players and DVD players in the following situation:
When the input mode has been set to AUTO and a search is performed while playing the source encoded with a Dolby Digital or DTS signal, the sound may delay for a moment when playback is resumed.
- Depending on the LD player, playback may not be made when playing an LD that is not digitally recorded with the input mode set to AUTO. If this happens, set the input mode to ANALOG.

■ Notes on playing a source encoded with a DTS signal

- If the digital output data of the player has been processed in any way, you may not be able to perform DTS decoding even if you make a digital connection between this unit and the player.
- If you play a source encoded with a DTS signal and set the input mode to ANALOG, this unit reproduces the noise of an unprocessed DTS signal. When you want to play a DTS source, be sure to connect the source to a digital input jack and set the input mode to AUTO or DTS.
- If you switch the input mode to ANALOG while playing a source encoded with a DTS signal, this unit reproduces no sound.
- The following phenomena may occur if the input mode is set to AUTO when playing back source encoded with a DTS signal.
 - If you continue to play a source encoded with a DTS signal, this unit automatically switches to the “DTS-decoding” mode to prevent noise from being generated during subsequent operation. (The “**dts**” indicator lights up on the front panel display.) The “**dts**” indicator may flash immediately after playback of a source encoded with a DTS signal has finished. Only a source encoded with a DTS signal can be played back while this indicator is flashing. (The indicator will flash for less than a minute.) If you want to play a normal PCM source soon, set the input mode back to AUTO.
 - The “**dts**” indicator may flash when a search or skip operation is performed. If this status continues for a certain length of time, the unit will automatically switch from the “DTS-decoding” mode to PCM digital signal input mode and the “**dts**” indicator will go out.

Selecting a Sound Field Program

You can enhance your listening experience by selecting a DSP program. For details about each program, see “SOUND FIELD PROGRAM”.

■ On the remote control

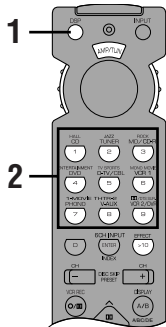

1 Press DSP.

The indicator lights up for about 3 seconds.



- If the selector dial is set to the DSP/TUN position, skip this step.

2 Use the numeric buttons to select the desired program before the indicator goes off.

- For example, to select the sub-program “SPECTACLE”, press MOVIE THEATER 1 repeatedly.
- The name of the selected program appears on the front panel display and on the video monitor.

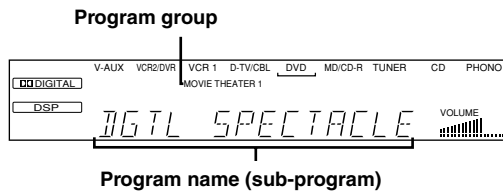
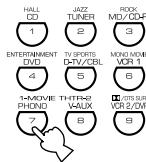

■ On the front panel

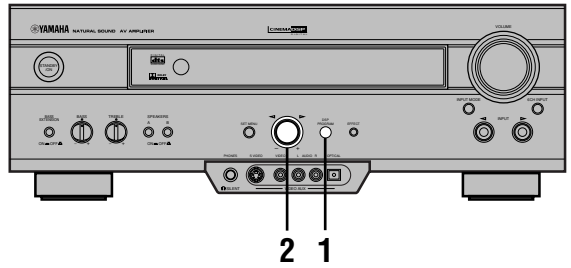

1 Press DSP PROGRAM.



2 Turn the multi jog knob to select the program.

The name of the selected program appears on the front panel display and on the video monitor.



Notes

- Choose a DSP program based on your listening preference, and not on the name of the program. The acoustics of your listening room affect the DSP program. Minimize the sound reflections in your room to maximize the effect created by the program.
- When you select an input source, this unit automatically selects the last DSP program used with that source.
- When you set this unit in the standby mode, the current source and DSP program are memorized and are automatically selected when you turn on the power again.
- If a Dolby Digital or DTS signal is input when the input mode is set to AUTO, the DSP program automatically switches to the appropriate decoding program.
- When a monaural source is being played with PRO LOGIC/NORMAL or PRO LOGIC/ENHANCED, no sound will be heard from the main speakers and the rear speakers. Sound can only be heard from the center speaker. However, if “1A CENTER SP” on the SET MENU is set to NONE, the center channel sound is output from the main speakers.
- When a source connected to the 6CH INPUT jacks of this unit is selected, the digital sound field processor cannot be used.
- When 96-kHz sampling digital signals are input to this unit, the DSP program cannot be selected. In this case, the sound is reproduced as normal 2-channel stereo.

■ Virtual CINEMA DSP and SILENT CINEMA

Virtual CINEMA DSP

Virtual CINEMA DSP allows you to enjoy the sound field effects of the DSP program without rear speakers. Using YAMAHA original technology, natural surround reproduction is possible through the generation of a virtual speaker.

The sound field processing is changed to the Virtual CINEMA DSP mode by setting “1C REAR L/R SP” on the SET MENU to NONE. Virtual CINEMA DSP is performed by using the main speakers.

Note

- This unit is not set in the Virtual CINEMA DSP mode even if “1C REAR L/R SP” is set to NONE in the following cases:
 - when the 5CH STEREO, PRO LOGIC/NORMAL, DOLBY DIGITAL/NORMAL or DTS/NORMAL program is selected;
 - when the sound effect is turned off;
 - when 6CH INPUT is selected as the input source;
 - when 96-kHz sampling digital signals are input to this unit;
 - when the Dolby Digital KARAOKE source is played;
 - when using the test tone; or
 - when connecting the headphones (you will hear SILENT CINEMA).

SILENT CINEMA

SILENT CINEMA allows you to enjoy the realistic feel of the DSP program while using headphones. This feature delivers powerful surround reproduction just as if listening through the speakers.

You can listen to SILENT CINEMA by connecting your headphones to the PHONES jack while the effect speakers are on.

Normal Stereo Reproduction

Press EFFECT to turn off the sound effect for normal stereo reproduction.

Press EFFECT again to turn the sound effect back on.

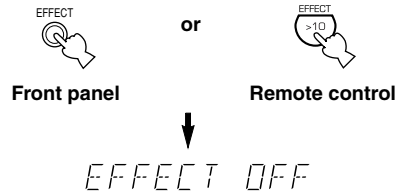

- If the selector dial is set to a position other than the DSP/TUN position, first press DSP and then EFFECT on the remote control.

Notes

- If you turn off the sound effect, no sound is output from the center and rear speakers.
- If you turn off the sound effect while a Dolby Digital or DTS signal is being output, the dynamic range of the signal is automatically compressed and the sounds of the center and rear speaker channels are mixed and output from the main speakers.
- The volume may be greatly reduced when you turn off the sound effect or if you set “6 D-RANGE” on the SET MENU to MIN. In this case turn on the sound effect.

BASIC RECORDING

Recording adjustments and other operations are performed from the recording components. Refer to the operation instructions for these components.

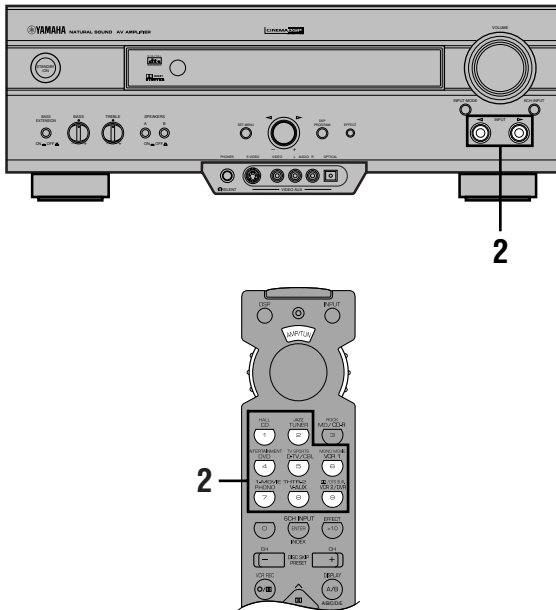

1 Turn on the power to the unit and all connected component.

2 Select the source component you want to record from.

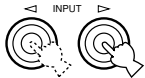

Front panel

or

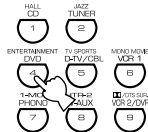

Remote control

3 Start playback (or select a broadcast station) on the source component.

4 Start recording on the recording component.

Notes

- Do a test recording before you start an actual recording.
- When this unit is set in the standby mode, you cannot record between other components connected to this unit.
- The setting of BASS, TREBLE, BASS EXTENSION, VOLUME, "2 L/R BALANCE" on the SET MENU and DSP programs does not affect the recorded material.
- A source connected to the 6CH INPUT jacks of this unit cannot be recorded.
- S-video and composite video signals pass independently through this unit's video circuits. Therefore, when recording or dubbing video signals, if your video source component is connected to provide only an S-video (or only a composite video) signal, you can record only an S-video (or only a composite video) signal by your VCR.
- A given input source is not output on the same REC OUT channel. (For example, the signal input from VCR 1 IN is not output on VCR 1 OUT.)
- Check the copyright laws in your country to record from records, CDs, radio, etc. Recording of copyrighted material may infringe copyright laws.

If you playback a video source that uses scrambled or encoded signals to prevent it from being dubbed, the picture itself may be disturbed due to those signals.

Special considerations when recording DTS software

The DTS signal is a digital bitstream. Attempting to digitally record the DTS bitstream will result in noise being recorded. Therefore, if you want to use this unit to record sources that have DTS signals recorded on them, the following considerations and adjustments need to be made.

For DVDs and CDs encoded with DTS

Only 2-channel analog audio signals may be recorded. Set the DVD player (or CD player) as described in the player's operation instructions so that the audio signals are output from the player's analog outputs.

SET MENU

The SET MENU consists of 10 items including the speaker mode setting features. Use the SET MENU to enjoy the optimum audio/video playback for your system.



- You can adjust the items on the SET MENU while playing a source.
- We recommend that you adjust the items on the SET MENU while using a video monitor. It is easier to see the video monitor than it is to see the front panel display on this unit while adjusting the items.

Note

- The indication on the front panel display is the abbreviation of the OSD.

1 SPEAKER SET

- 1A CENTER SP
- 1B MAIN SP
- 1C REAR L/R SP
- 1D LFE/BASS OUT
- 1E MAIN LEVEL

2 L/R BALANCE

3 HP TONE CTRL

4 I/O ASSIGNMENT

- 4A CMPNT-V INPUT
- 4B OPTICAL OUT
- 4C OPTICAL IN
- 4D COAXIAL IN

5 INPUT MODE

6 DOLBY D. SET

- LFE LEVEL
- D-RANGE

7 DTS SET

8 SP DELAY TIME

9 DISPLAY SET

- BLUE BACK
- OSD SHIFT
- DIMMER

10 MEMORY GUARD

Adjusting the Items on the SET MENU

Adjustment should be made with the remote control.

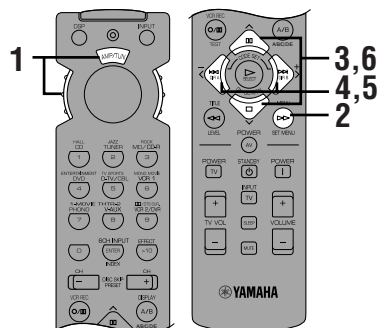

Notes

- Some items require extra steps to change to the desired setting.
- SET MENU and the multi jog knob on the front panel can also be used to make these adjustments.

- Set the selector dial to the AMP/TUN (or DSP/TUN) position.



- Press SET MENU to enter the SET MENU.



SET MENU 1/3

- 1 SPEAKER SET
- 2 L/R BALANCE
- 3 HP TONE CTRL
- 4 I/O ASSIGNMENT
- ▲/▼ : Up/Down
- /+ : Enter

- Press repeatedly to select the item (1 to 10) you want to adjust.

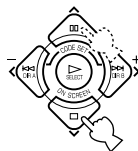

SET MENU 1/3

- 1 SPEAKER SET
- 2 L/R BALANCE
- 3 HP TONE CTRL
- 4 I/O ASSIGNMENT
- ▲/▼ : Up/Down
- /+ : Enter



- By pressing SET MENU (or SET MENU on the front panel) repeatedly, you can select items in the same order as when pressing .

4 Press < or > once to enter the setup mode of the selected item.

The last setting you adjusted appears on the video monitor or on the front panel display.

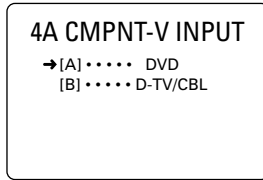
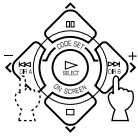

- When making adjustments through the front panel, turn the multi jog knob one step to either the left or the right to enter setup mode for the selected item.

Depending on the item, press ^/∨ to select a sub item.

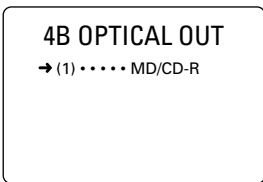
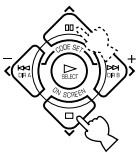

- When making adjustments through the front panel, press SET MENU.

5 Press </> repeatedly to change the setting of the item.

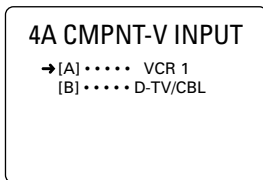
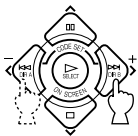

- When making adjustments through the front panel, turn the multi jog knob to change the settings.

6 Press ^/∨ repeatedly until the current DSP program appears or simply press one of the DSP program group button to exit from the SET MENU.

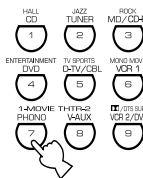
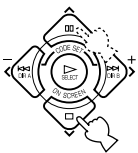

- When operating through the front panel, press SET MENU repeatedly until the DSP program name appears to exit from the SET MENU.

Memory back-up

The memory back-up circuit prevents the stored data from being lost even if this unit is set in the standby mode, the power cord is disconnected from the AC outlet, or the power supply is temporarily cut due to power failure. However, if the power is cut for more than one week, the settings of the SET MENU you adjusted will return to the factory settings. If so, adjust the items again.

1 SPEAKER SET (speaker mode settings)

Use this feature to select suitable output modes for your speaker configuration.

Notes

- When 96-kHz sampling digital signals are input to this unit, level adjustments in items 1B and 1D are possible, but those in items 1A, 1C and 1E are not affected.
- When 6CH INPUT is selected as the input source, level adjustments in items 1A through 1E are not affected.

1A CENTER SP (center speaker mode)

By adding a center speaker to your speaker configuration, the unit can provide good dialog localization for many listeners and superior synchronization of sound and images. The OSD shows a large, small or no center speaker depending on how you set this item.

Choices: LRG (large), SML (small), NONE
Initial setting: LRG

LRG

Select this if you have a large center speaker. The entire range of the center channel signal is directed to the center speaker.

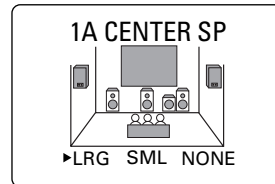

SML

Select this if you have a small center speaker. The low-frequency signals (90 Hz and below) of the center channel are directed to the speakers selected with "1D LFE/BASS OUT".

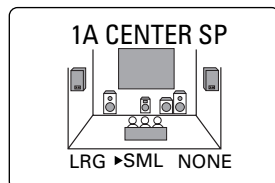

NONE

Select this if you do not have a center speaker. All of the center channel signals are directed to the left and right main speakers.

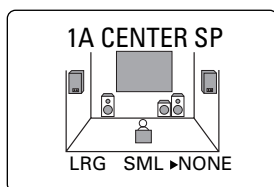
**1B MAIN SP (main speaker mode)**

The OSD shows large or small main speakers depending on how you set this item.

Choices: LARGE, SMALL

Initial setting: LARGE

LARGE

Select this if you have large main speakers. The entire range of the left and right main channel signal is directed to the left and right main speakers.

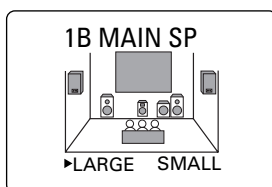
**SMALL**

Select this if you have small main speakers. The low-frequency signals (90 Hz and below) of the main channel are directed to the speakers selected with "1D LFE/BASS OUT".

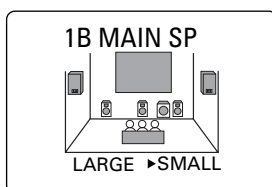
**Note**

- When you select MAIN for "1D LFE/BASS OUT", the low-frequency signals (90 Hz and below) of the main channel are directed to the main speakers even if you select SMALL for the main speaker mode.

1C REAR L/R SP (rear speaker mode)

The OSD shows large, small or no rear speakers depending on how you set this item.

Choices: LRG (large), SML (small), NONE

Initial setting: LRG

LRG

Select this if you have large left and right rear speakers or if a rear subwoofer is connected to the rear speakers. The entire range of the rear channel signal is directed to the left and right rear speakers.

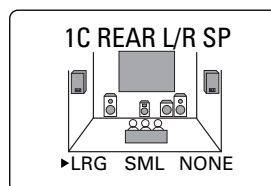
**SML**

Select this if you have small left and right rear speakers. The low-frequency signals (90 Hz and below) of the rear channel are directed to the speakers selected with "1D LFE/BASS OUT".

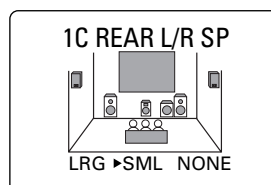
**NONE**

Select this if you do not have rear speakers.

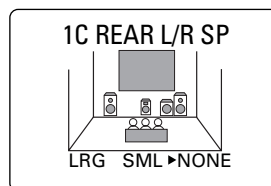

- This unit is set in the Virtual CINEMA DSP mode by selecting NONE for "1C REAR L/R SP".

■ 1D LFE/BASS OUT (bass out mode)

LFE signals carry low-frequency effects when this unit decodes a Dolby Digital or DTS signal. Low-frequency signals are defined as 90 Hz and below.

Choices: SWFR (subwoofer), MAIN, BOTH
Initial setting: BOTH

SWFR

Select this if you use a subwoofer. The LFE signals are directed to the subwoofer.

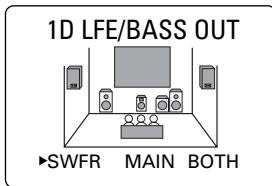

MAIN

Select this if you do not use a subwoofer. The LFE signals are directed to the main speakers.

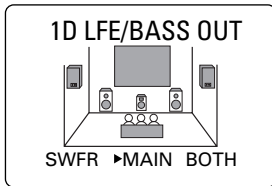

BOTH

Select this if you use a subwoofer and you want to mix the main channel low-frequency signals with the LFE signals.



Notes

- When playing a 2-channel source (CD, MD, tape, video cassette etc.), select the BOTH position to direct low bass signals (below 90 Hz) to the SUBWOOFER jack.
- When you select SMALL (SML) for items 1A, 1B and 1C, the low-frequency signals (90 Hz and below) from those channels are added to the LFE and output to the subwoofer.

■ 1E MAIN LEVEL (main level mode)

Change this setting if you cannot match the output level of the center and rear speakers with the main speakers because of the unusually high-efficiency performance of the main speakers.

Choices: Normal, -10 dB
Initial setting: Normal

Normal

Normally select this setting.

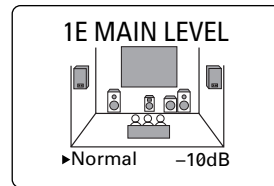

-10 dB

Select this if you cannot match the output level of your effect speakers with that of your main speakers when using the test tone. This setting decreases the main speaker output level to about one-third of the normal level.

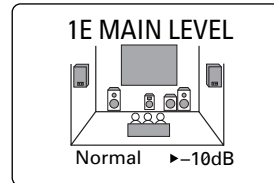

2 L/R BALANCE (balance of the left and right main speakers)

Use this feature to adjust the balance of the output level from the left and right main speakers.

Control range: 10 for L/R
Initial setting: 0

Press > to decrease the output level for the left main speaker. Press < for the right main speaker.

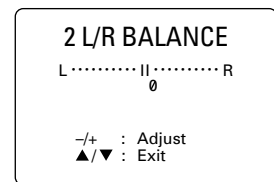

Note

- The L/R BALANCE setting also applies to when headphones are being used.

3 HP TONE CTRL (headphone tone control)

Use this feature to adjust the level of the bass and treble when you use your headphones.

Control range (dB): -6 to +3

Initial setting: 0 dB for both BASS and TRBL (treble)

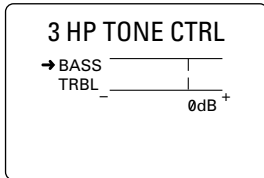

4 I/O ASSIGNMENT

It is possible to assign jacks according to the component to be used if this unit's COMPONENT VIDEO input jack or DIGITAL INPUT/OUTPUT jack settings (component names for jacks) differ from that component. This makes it possible to change the jack assignment and effectively connect more component.

Once you assign, you can select that component with INPUT ◀/▶ (or the input selector buttons).

■ 4A CMPNT-V INPUT (for the COMPONENT VIDEO jacks)

Initial settings: [A] DVD

[B] D-TV/CBL

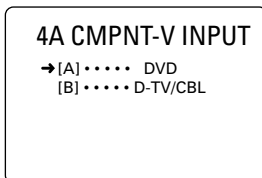

■ 4B OPTICAL OUT (for the OPTICAL OUTPUT jack)

Initial setting: (1) MD/CD-R

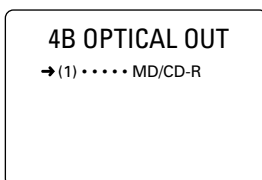

■ 4C OPTICAL IN (for the OPTICAL INPUT jacks)

Initial settings: (2) MD/CD-R

(3) DVD

(4) D-TV/CBL

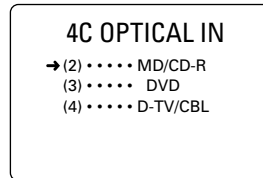

■ 4D COAXIAL IN (for the COAXIAL INPUT jack)

Initial setting: (5) CD

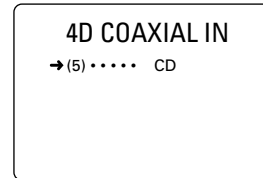

Note

- You cannot select an item more than once for the same type of jack.

5 INPUT MODE (initial input mode)

Use this feature to designate the input mode when turning on the power of this unit with the source component connected to more than one type of input jacks.

Choices: AUTO, LAST

Initial setting: AUTO

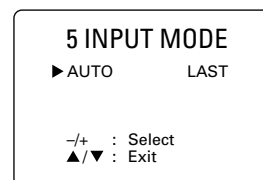

AUTO

Select this to allow this unit to automatically detect the type of input signal and select the appropriate input mode.

LAST

Select this to set this unit to automatically select the last input mode used for that source.

6 DOLBY D. SET (Dolby Digital set)

This setting is effective only when this unit decodes Dolby Digital signals.

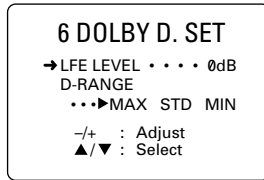

■ LFE LEVEL

Use this feature to adjust the output level of the LFE (low-frequency effect) channel when playing back a Dolby Digital signal. The LFE signal carries the low-frequency special effect sound which is only added to certain scenes.

Control value (dB): -20 to 0

Initial setting: 0 dB

Notes

- Adjust the LFE level according to the capacity of your subwoofer.
- Normally, around -6 dB to -8 dB is most suitable for listening at home.

■ D-RANGE (dynamic range)

Use this feature to adjust the dynamic range (the difference between the maximum level and the minimum level of sounds).

Choices: MAX, STD (standard), MIN

Initial setting: MAX

- Select MAX for feature films.
- Select STD for general use.
- Select MIN for listening to sources at an extremely low volume level.

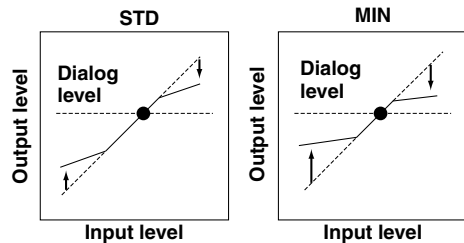
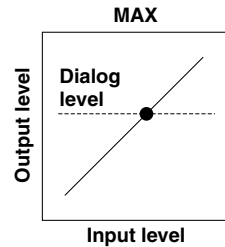

Note

- When you select MIN, the sound output may be faint because some Dolby Digital signals are not compatible with the minimum-level dynamic range. In this case, select MAX or STD.

7 DTS SET (DTS LFE level)

This setting is effective only when this unit decodes DTS signals.

Use this feature to adjust the output level of the LFE (low-frequency effect) channel when playing back a DTS signal. The LFE signal carries the low-frequency special effect sound which is only added to certain scenes.

Control range (dB): -10 to +10

Initial setting: 0 dB

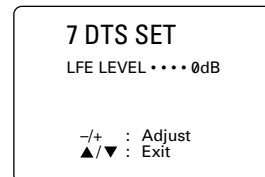

Note

- Adjust the LFE level according to the capacity of your subwoofer.

8 SP DELAY TIME

Use this feature to adjust the delay of the center channel sound. This feature works when this unit decodes a Dolby Digital or DTS signal. Ideally, the center speaker should be the same distance from the listening position as the left and right main speakers. However, in most home situations, the center speaker is placed in line with the main speakers. By delaying the sound from the center speaker, the apparent distance from the center speaker to the listening position can be adjusted to make it seem the same as the distance between the left and right main speakers to the listening position. Adjusting the delay time for the center speaker is especially important for giving depth to the dialog.

Control range (ms): 0 to 5

Initial setting: 0 ms

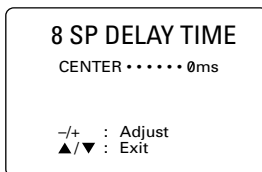

Center speaker image

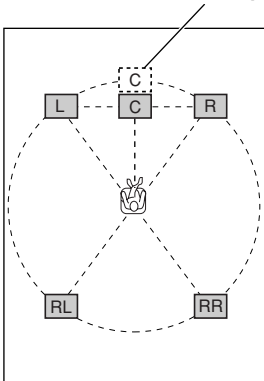

- Increasing the delay by 1 ms simulates moving the speaker about 30 cm (one foot) farther away from the actual position of the center speaker.

9 DISPLAY SET

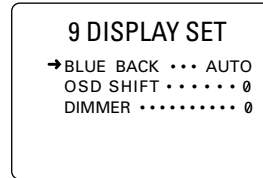

■ BLUE BACK

Selecting AUTO for the on-screen display setting displays a blue background when there's no video signal input. Nothing is displayed on the screen including the on-screen display if OFF is selected.

Initial setting: AUTO

■ OSD SHIFT (OSD off-set position)

This setting is used to adjust the vertical position of the OSD.

Control range: +5 (downward) to -5 (upward)

Initial setting: 0

Press > to lower the position of the OSD.

Press < to raise the position of the OSD.

■ DIMMER

You can adjust the brightness of the front panel display.

Control range: -4 to 0

Initial setting: 0

10 MEMORY GUARD

Use this feature to prevent accidental changes to DSP program parameter values and other settings on this unit.

Choices: ON, OFF

Initial setting: OFF



Select ON to protect the following features:

- DSP program parameters
- All SET MENU items
- Center, rear speakers and subwoofer levels
- The on-screen display (OSD) mode

Notes

- When "10 MEMORY GUARD" is set to ON, you cannot use the test tone.
- When "10 MEMORY GUARD" is set to ON, you cannot select any other SET MENU items.

ADJUSTING THE LEVEL OF THE EFFECT SPEAKERS

You can adjust the output level of each effect speaker (center, left and right rear and subwoofer) while listening to a music source.

Adjustment should be made with the remote control.

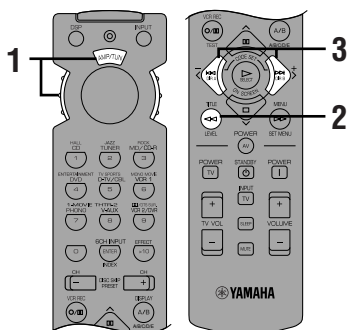

3 Press </> to adjust the speaker output level.

- The control range for the center or left and right rear speakers is from +10 dB to -10 dB.
- The control range for the subwoofer is from 0 dB to -20 dB.

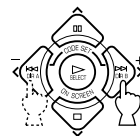

Notes

- If the speaker output mode is set to NONE, the output level of that speaker cannot be adjusted.
- When you adjust the output level with LEVEL, the settings you made with the test tone will be changed.
- To adjust speakers other than the subwoofer, the adjusting procedure using the test tone on page 22 is recommended.

1 Set the selector dial to the AMP/TUN (or DSP/TUN) position.



2 Press LEVEL repeatedly to select the speaker(s) you want to adjust.

Each time you press LEVEL, the selected speaker changes and appears on the front panel display and on the video monitor as follows: center, right rear, left rear and subwoofer.

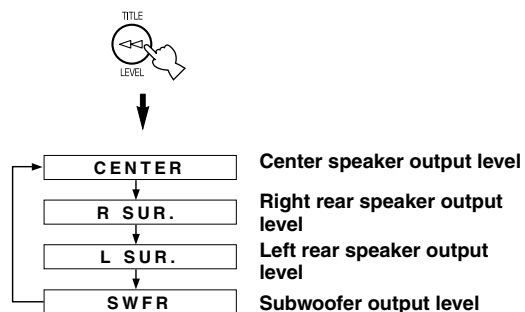

Memory back-up

The memory back-up circuit prevents the stored data from being lost even if this unit is set in the standby mode, the power cord is disconnected from the AC outlet, or the power supply is temporarily cut due to power failure. However, if the power is cut for more than one week, the output level of the effect speakers you adjusted will return to the factory settings. If so, adjust the output level again.



- Once you press LEVEL, you can also select the speaker(s) to be adjusted by pressing ∨. (Pressing ∧ changes the selection in the reverse order.)

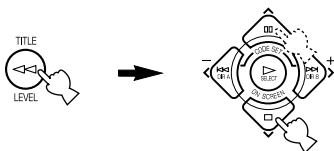

SLEEP TIMER

Use this feature to automatically set this unit in the standby mode after the amount of time you have set. The sleep timer is useful when you are going to sleep while this unit is playing or recording a source. The sleep timer also automatically turns off the external components connected to AC OUTLET(S).

The sleep timer can only be set with the remote control.

Setting the Sleep Timer

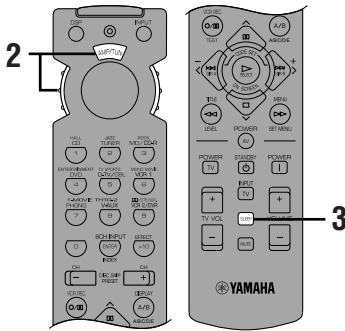

1 Select a source and start playback on the source component.

2 Set the selector dial to a position other than the TV position.



3 Press SLEEP repeatedly to set the amount of time before this unit automatically turns off.



Each time you press SLEEP, the front panel display changes as shown below.

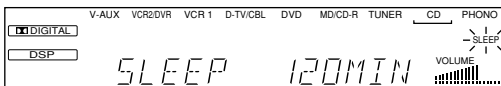
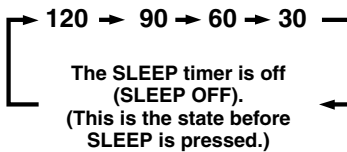

4 The “SLEEP” indicator soon lights up on the front panel display after the sleep timer has been set.

The display then returns to the previous indication.

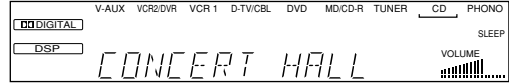

Canceling the Sleep Timer

Press SLEEP repeatedly until “SLEEP OFF” appears on the front panel display.

After a few seconds, “SLEEP OFF” disappears, the “SLEEP” indicator goes off and the display returns to the previous indication.

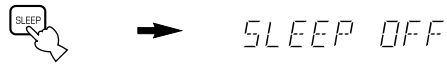

- The sleep timer setting can also be canceled by setting this unit in the standby mode by using STANDBY on the remote control (or STANDBY/ON on the front panel) or by disconnecting the AC power cord from the AC outlet.

REMOTE CONTROL FEATURES

It is possible to control this unit and other YAMAHA A/V components using the remote control supplied with this unit. It is also possible to control components from other manufacturers (or some YAMAHA components) by setting the proper manufacturer code (a signal assigned to each manufacturer and component).

Note

- For the notes on batteries, operating distance and names and functions of the remote control, refer to each description in this manual.

Selector Dial

Select the component (position) to be controlled by the remote control. For example, if the CD position is selected, the remote control is set in the CD operation mode, allowing the CD player to be controlled. When turning the selector dial, the position changes as follows:

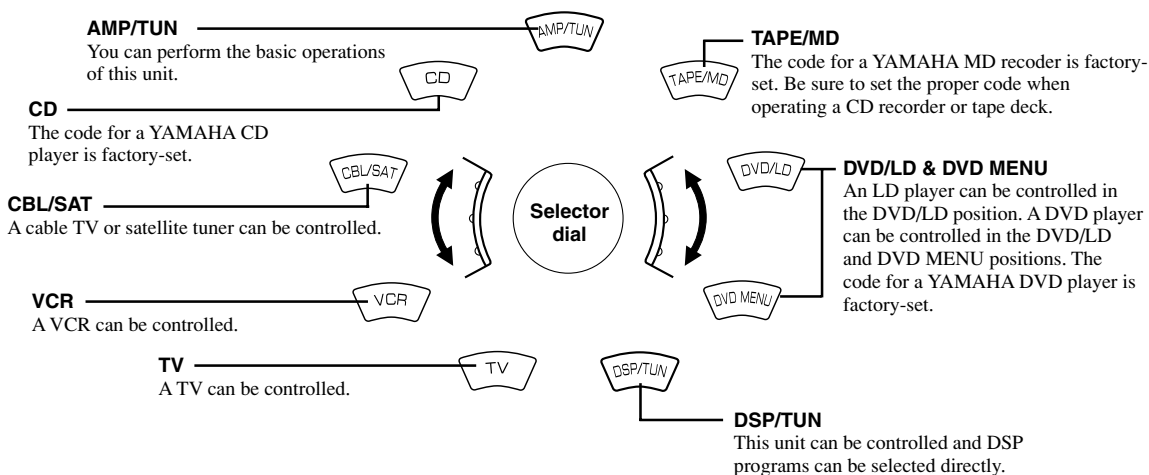

Notes

- The general operational buttons on the remote control differ depending on the position of the selector dial. See the following pages for details.
- When shipped from the factory, the YAMAHA manufacturer codes listed on page 46 are set for each dial position. If unable to operate your YAMAHA A/V component, please try using another YAMAHA code.

Commonly Used Buttons in Any Position of the Selector Dial

Regardless of the position of the selector dial, you can control this unit and your TV with the following buttons.

Note

- You have to set up the code for your TV in the TV position before you can control the TV.

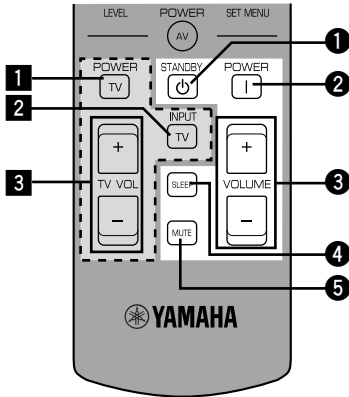

Controlling this unit

See “Remote Control”.

- 1 STANDBY
- 2 POWER
- 3 VOLUME +/-
- 4 SLEEP

Note

- If you have set up the code for your TV and set the selector dial to the TV position, this button is used to set the sleep timer for the TV.

- 5 MUTE

Note

- If you have set up the code for your TV and set the selector dial to the TV position, this button is used to mute the TV sound.

Controlling your TV

- 1 TV POWER
- 2 TV INPUT
- 3 TV VOLUME +/-

Controlling the Components Connected to This Unit

The example below describes the procedure for controlling a YAMAHA CD player.

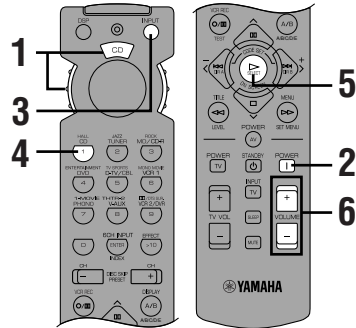

- 1 Set the selector dial to the CD position.



- 2 Turn on the power.



- 3 Press INPUT.

The indicator lights up for about 3 seconds.



- 4 Press CD while the indicator is lit.



- 5 Press .

See “Button Names and Functions in Each Position” for the CD player operation buttons.

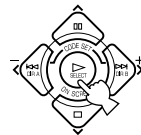

- 6 Adjust the volume.



If you set the remote control with the manufacturer codes **listed from page i at the end of this manual**, you can control other brands of components. See “Setting the Manufacturer Codes” for details.

Button Names and Functions in Each Position

■ TAPE/MD position (tape deck, MD recorder or CD recorder)

Select the TAPE/MD position.

AV POWER
This button turns on the tape deck, MD recorder or CD recorder that has a remote control with a power button if you have set up the code for another manufacturer.

◀◀ DIR A (tape)
This button selects the playing direction of deck A.
Skip - (MD/CD-R)

▶ Play

▢ Pause (MD/CD-R)

▶▶ Fast forward (tape)
Search (MD/CD-R)

▶▶ Skip + (MD/CD-R)

◻ Stop

DISPLAY (MD/CD-R)
◻◻ DIR B (tape)
This button selects the playing direction of deck B.

Deck A/B (tape)
This button selects deck A or B on a double-cassette tape deck.

+10 (MD/CD-R)

INDEX (CD-R)

Numeric buttons (MD/CD-R)

■ CD position

Select the CD position.

AV POWER
This button turns on the CD player that has a remote control with a power button if you have set up the code for another manufacturer.

◻◻ Pause
YAMAHA CD player (factory settings): Pause/Stop

▶▶ Skip +

◻ Stop
YAMAHA CD player (factory settings): Pause/Stop

▶▶ Search

DISC SKIP -/+ (for a CD player with CD changer)

▶ Play

◀◀ Skip -

◀◀ Search

+10

INDEX

DISPLAY

☀️ Pause/Stop function
• Press the button once to give a pause in operation and press once more to stop operation.

Numeric buttons

- The dark-shaded buttons do not function even if you have set up the manufacturer code.
- Some of them may not function depending on the component you have. In this case, use the original remote control supplied with your component.

DVD/LD position

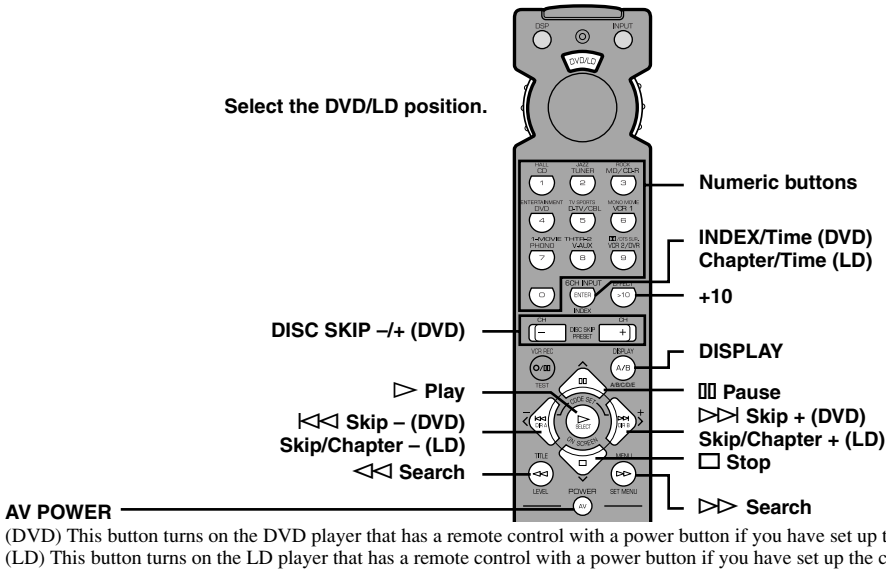

(DVD) This button turns on the DVD player that has a remote control with a power button if you have set up the code for another manufacturer.
(LD) This button turns on the LD player that has a remote control with a power button if you have set up the code for another manufacturer.

DVD MENU position

Note

- DVD MENU operations cannot be performed for some DVD players.

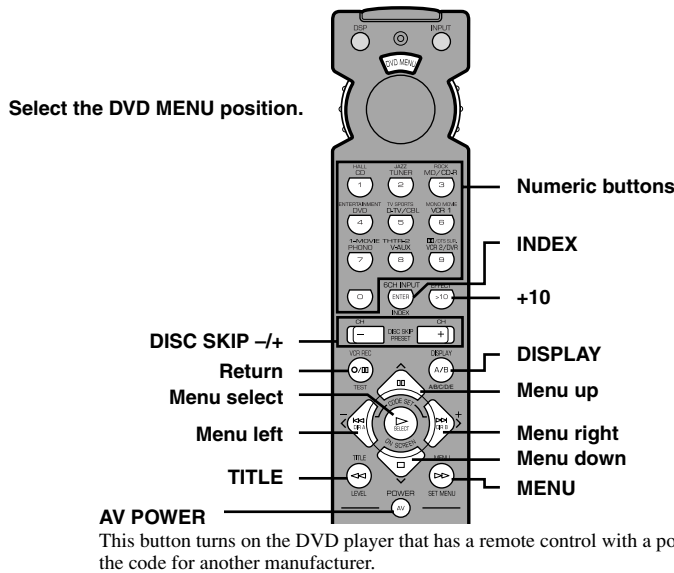

- The dark-shaded buttons do not function even if you have set up the manufacturer code.
- Some of them may not function depending on the component you have. In this case, use the original remote control supplied with your component.

■ VCR position

■ CBL/SAT position

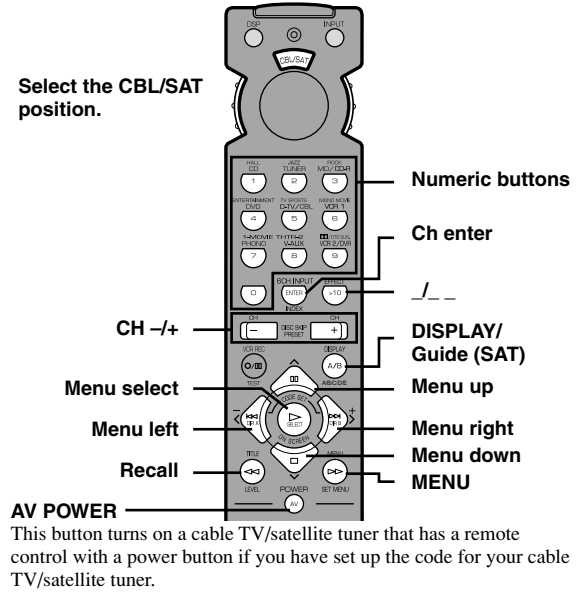
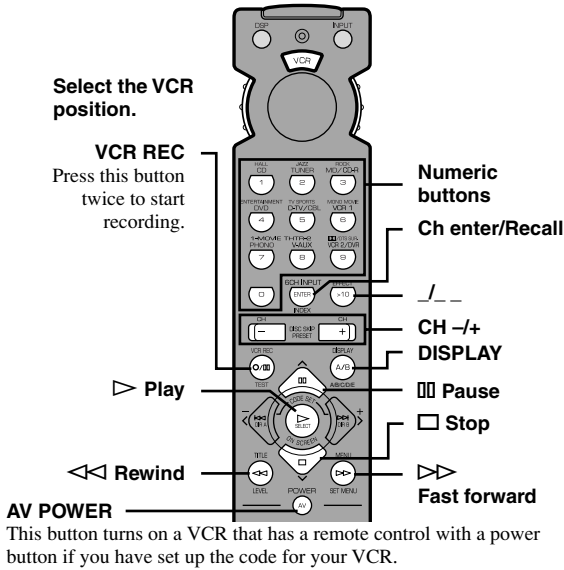

■ TV position

Note

- You can control your VCR if you have set up the code for it in the VCR position.

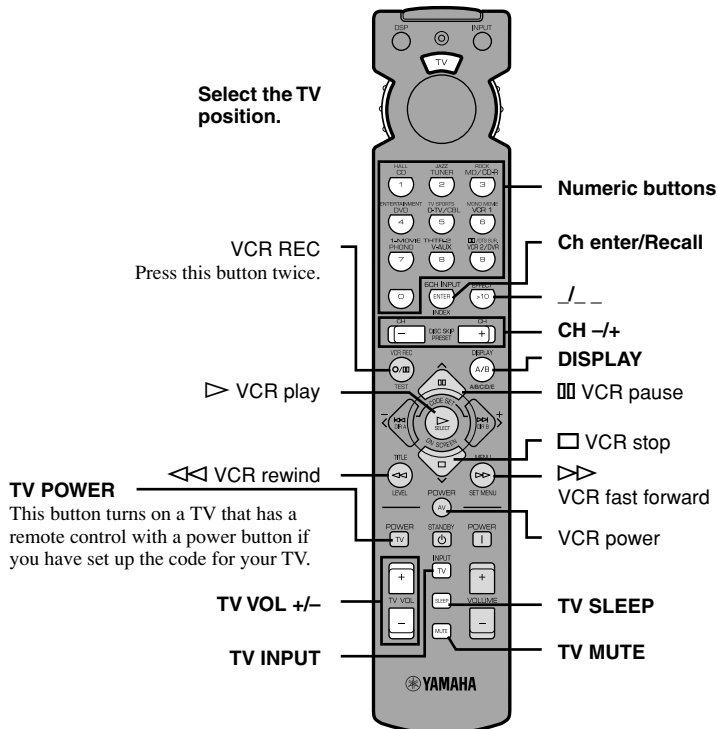

- The dark-shaded buttons do not function even if you have set up the manufacturer code.
- Some of them may not function depending on the component you have. In this case, use the original remote control supplied with your component.

Setting the Manufacturer Code

You can set up the code for the manufacturer of your component in each position of the selector dial.

1 Turn on your component to be used.

2 Set the selector dial to the desired position for the component (TAPE/MD, CD, DVD/LD, etc.).

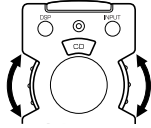

3 Press </> at the same time for about 4 seconds.

The indicator flashes twice.

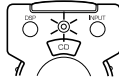
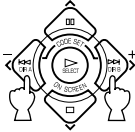

4 Use the numeric buttons to enter the four-digit manufacturer code for the component to be used. Make sure that the indicator flashes twice.

If the indicator does not flash or flashes rapidly several times, repeat step 3 and re-enter the code.

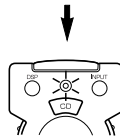
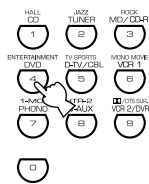

5 Press AV POWER (or any other button) to check if you have set up the code correctly.

If your component cannot be controlled with the remote control, try setting another code for the same manufacturer.



Notes

- You can set up only one code for one position.
- In the DVD/LD and DVD MENU positions: Be sure to set the selector dial to the DVD/LD position before entering the code for the DVD/LD player. You cannot set up the code for a DVD player when the selector dial is set to the DVD MENU position. The code set up in the DVD/LD position is also simultaneously set up in the DVD MENU position.
- If your component does not respond to any of the codes listed for the manufacturer, use the original remote control supplied with your component.

To use a second (and third) VCR

You can control a second (and third) VCR in the CBL/SAT and DVD MENU positions if a cable TV/satellite tuner or DVD player is not being used.

Note

- In order to set a second (and third) VCR in the DVD MENU position, it is necessary to first set up the code for an LD player in the DVD/LD position.

1 Turn on the VCR to be used.

2 Set the selector dial to the CBL/SAT or DVD MENU position.

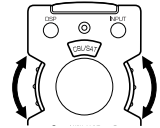

3 Press </> at the same time for about 4 seconds.

The indicator flashes twice.

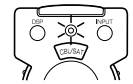
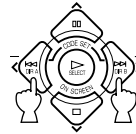

4 Use the numeric buttons to enter the four-digit code for the second (and third) VCR. Make sure that the indicator flashes twice.

If the indicator does not flash or flashes rapidly several times, repeat step 3 and re-enter the code.

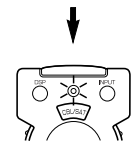
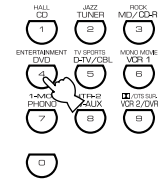

5 Press AV POWER (or any other button) to check if you have set up the code correctly.

If the VCR cannot be controlled with the remote control, try setting another code for the same manufacturer.



Returning to the Factory Setting

To return to the factory-set codes in all positions

1 Press **</>** at the same time for about 4 seconds.

The indicator flashes twice.

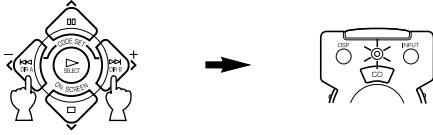

2 Enter the code number "9990".

Make sure that the indicator flashes twice.

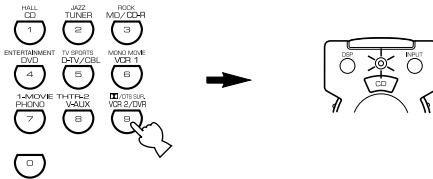

To return to the factory-set codes in each position

1 Set the selector dial to the position for the component to be returned to the factory setting.

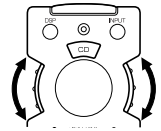

2 Press **</>** at the same time for about 4 seconds.

The indicator flashes twice.

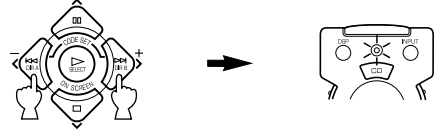

3 Enter the code number "0000".

Make sure that the indicator flashes twice.

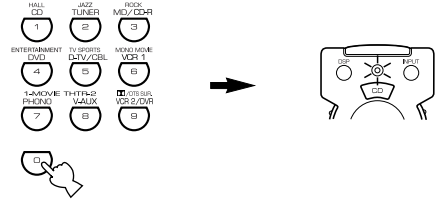

The following codes are factory set.

| Selector dial position | Component | Code | Set component | Set code |
|------------------------|-----------------|---------------------------|---------------|----------|
| TV | TV | 0101 | | |
| CBL/SAT | Satellite tuner | 0006 | | |
| VCR | VCR | 0002 | | |
| DVD/LD | DVD player | 0008 (YAMAHA DVD player) | | |
| CD | CD player | 0005 (YAMAHA CD player) | | |
| TAPE/MD | MD recorder | 0024 (YAMAHA MD recorder) | | |

We recommend that you write all the code numbers you have set on the table above.

SOUND FIELD PROGRAM

A digital sound field processor (DSP) based on the latest YAMAHA technology is built into this unit. It is possible to play back various sound fields for the source you are listening to.

Note

- Regardless of the program name and characteristics listed in the table below, select the sound field program that sounds best to you.

Hi-Fi DSP Programs

■ For audio sources: Nos. 1 to 4

| No. | Program (group) | Sub-program | Features |
|-----|-----------------|-------------|---|
| 1 | CONCERT HALL | — | A large round concert hall with a rich surround effect. Pronounced reflections from all directions emphasize the extension of sounds. The sound field has a great deal of presence, and your virtual seat is near the center, close to the stage. |
| 2 | JAZZ CLUB | — | This is the sound field at stage front in “The Bottom Line”, a famous New York jazz club. The floor can seat 300 people to the left and right in a sound field offering a real and vibrant sound. |
| 3 | ROCK CONCERT | — | The ideal program for lively, dynamic rock music. The data for this program was recorded at LA’s “hottest” rock club. The listener’s virtual seat is at the center-left of the hall. |
| 4 | ENTERTAINMENT | DISCO | This program recreates the acoustic environment of a lively disco in the heart of a big city. The sound is dense and highly concentrated. It is also characterized by a high-energy, “immediate” sound. |
| | | 5CH STEREO | Using this program increases the listening position range. This is a sound field suitable for background music at parties. |

Note

- Reverberations (sound effects) for realizing the sound field and unprocessed stereo from the left and right main speakers is output. The sound is not output from the center speaker. (The sound is output when one of these programs is selected while playing a source encoded with a Dolby Digital or DTS signal. If 5CH STEREO is selected, the sound is output from all speakers regardless of the input source.)

CINEMA DSP Programs

■ For audio-video sources: Nos. 4 to 6

| No. | Program (group) | Sub-program | Features |
|-----|-----------------|-------------|--|
| 4 | ENTERTAINMENT | GAME | This program adds a deep and spatial feeling to video game sounds. |
| 5 | TV SPORTS | — | Although the presence sound field is relatively narrow, the surround sound field employs the sound environment of a large concert hall. With this program, you can enjoy watching various TV programs such as news, variety shows, music programs or sports programs. In a stereo broadcast of a sports game, the commentator is oriented at the center position, and the shouts and the atmosphere in the stadium spread on the surround side, while their spread to the rear is properly restrained. |
| 6 | MONO MOVIE | — | This program is provided for reproducing monaural video sources (such as old movies). The program produces the optimum reverberation to create sound depth by using only the presence sound field. |

■ For movie programs: Nos. 7 to 9

| No. | Program (group) | Sub-program | | Input source | Features | | | |
|----------|---------------------------|-------------|----------------------------|---|--|---|---|---|
| 7 | MOVIE THEATER 1 | SPECTACLE | 70 mm SPECTACLE | Analog, PCM, Dolby Digital in 2-channel | This program creates the extremely wide sound field of a 70-mm movie theater. It precisely reproduces the source sound in detail, making both the video and the sound field incredibly real. This is ideal for any kind of video source encoded with Dolby Surround, Dolby Digital or DTS (especially large-scale movie productions). | | | |
| | | | DGTL SPECTACLE | Dolby Digital (5.1-channel) | | | | |
| | | | DTS SPECTACLE | DTS | | | | |
| | | SCI-FI | 70 mm SCI-FI | Analog, PCM, Dolby Digital in 2-channel | | This program clearly reproduces dialog and sound effects in the latest sound form of science fiction films, thus creating a broad and expansive cinematic space amid the silence. You can enjoy science fiction films in a virtual-space sound field that includes Dolby Surround, Dolby Digital and DTS-encoded software employing the most advanced techniques. | | |
| | | | DGTL SCI-FI | Dolby Digital (5.1-channel) | | | | |
| | | | DTS SCI-FI | DTS | | | | |
| 8 | MOVIE THEATER 2 | ADVENTURE | 70 mm ADVENTURE | Analog, PCM, Dolby Digital in 2-channel | This program is ideal for precisely reproducing the sound design of the newest 70-mm and multichannel soundtrack films. The sound field is made to be similar to that of the newest movie theaters, so the reverberations of the sound field itself are restrained as much as possible. | | | |
| | | | DGTL ADVENTURE | Dolby Digital (5.1-channel) | | | | |
| | | | DTS ADVENTURE | DTS | | | | |
| | | GENERAL | 70 mm GENERAL | Analog, PCM, Dolby Digital in 2-channel | | This program is for reproducing sounds from 70-mm and multichannel soundtrack films, and is characterized by a soft and extensive sound field. The presence sound field is relatively narrow. It spatially spreads all around and toward the screen, restraining the echo effect of conversations without losing clarity. For the surround sound field, the harmony of music or chorus sounds beautifully in a wide space at the rear of the sound field. | | |
| | | | DGTL GENERAL | Dolby Digital (5.1-channel) | | | | |
| | | | DTS GENERAL | DTS | | | | |
| | | 9 | Dolby Digital/DTS SURROUND | NORMAL | PRO LOGIC/NORMAL | | Analog, PCM, Dolby Digital in 2-channel | The built-in decoder precisely reproduces sounds and sound effects from sources. The highly efficient decoding process improves crosstalk and channel separation, and makes sound positioning smoother and more precise. In this program, the digital sound field processor is not turned on. |
| | | | | | DOLBY DIGITAL/NORMAL | | Dolby Digital (5.1-channel) | |
| | | | | | DTS DIGITAL SUR./NORMAL | | DTS | |
| ENHANCED | PRO LOGIC/ENHANCED | | | Analog, PCM, Dolby Digital in 2-channel | This program ideally simulates the multi-surround speaker systems of the 35-mm film theaters. Dolby Pro Logic decoding, Dolby Digital decoding or DTS decoding and digital sound field processing create precise effects without altering the original sound orientation. The surround effects produced by this sound field wrap around the viewer naturally from the back to the left and right, and toward the screen. | | | |
| | DOLBY DIGITAL/ENHANCED | | | Dolby Digital (5.1-channel) | | | | |
| | DTS DIGITAL SUR./ENHANCED | | | DTS | | | | |

Notes

- The “ DSP” indicator does not light up when selecting the sub-program “NORMAL” of the Dolby Digital/DTS SURROUND program.
- If “1A CENTER SP” on the SET MENU is set to NONE, no sound is output from the center speaker.
- The effect sound is output from the main speakers when a monaural source is played with CINEMA DSP program groups 4 (GAME) and 5 to 8.

■ MOVIE THEATER 1 and 2

Most commercially available movie software has 4-channel (left, center, right and surround) sound information encoded by Dolby Surround matrix processing and stored on the left and right tracks. These signals are processed by the Dolby Pro Logic decoder. The MOVIE THEATER programs are designed to recreate the spaciousness and delicate nuances of sound that tend to be lost in the encoding and decoding processes.

The 6-channel soundtracks found on 70-mm film produce precise sound field localization and rich, deep sound without using matrix processing. This unit's MOVIE THEATER 70 mm programs provide the same quality of sound and sound localization that 6-channel soundtracks do.

When the input source is analog, PCM or encoded with Dolby Digital in 2-channel

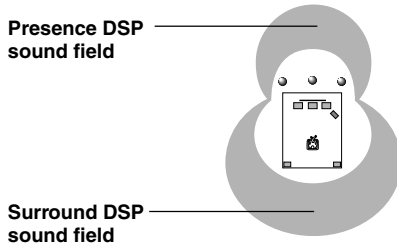

These programs express an immense sound field and a large surround effect. They also give depth to the sound from the main speakers to recreate the realistic sound of a Dolby Stereo theater.

70 mm SPECTACLE

70 mm SCI-FI

70 mm ADVENTURE

70 mm GENERAL

The built-in Dolby Digital or DTS decoder brings the professional-quality sound designed for movie theaters into your home. With the unit's MOVIE THEATER programs, you can recreate a dynamic sound that gives you the feeling of being at a public theater in your listening room by using Dolby Digital or DTS technology.

When the input source is encoded with Dolby Digital (5.1-channel) or DTS (Tri-Field CINEMA DSP)

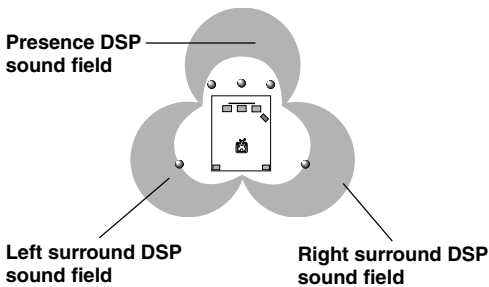

These programs use YAMAHA's tri-field DSP processing on each of the Dolby Digital or DTS signals for the front, left surround and right surround channels. This processing enables this unit to reproduce the immense sound field and surround expression of a Dolby Digital- or DTS-equipped movie theater without sacrificing the clear separation of all channels.

DGTL SPECTACLE

DTS SPECTACLE

DGTL SCI-FI

DTS SCI-FI

DGTL ADVENTURE

DTS ADVENTURE

DGTL GENERAL

DTS GENERAL



- If a Dolby Digital signal or DTS signal is input when the input mode is set to AUTO, the DSP program will be automatically switched to the Dolby Digital playback sound field or DTS playback sound field.

SOUND FIELD PROGRAM PARAMETER EDITING

What is a sound field?

What really creates the rich, full tones of a live instrument are the multiple reflections from the walls of the room. In addition to making the sound “live”, these reflections enable us to tell where the player is situated, and the size and shape of the room in which we are sitting.

■ Elements of a sound field

In any environment, in addition to the direct sound coming straight to our ears from the player’s instrument, there are two distinct types of sound reflections that combine to make up the sound field:

Early reflections

Reflected sounds reach our ears extremely rapidly (50 ms – 100 ms after the direct sound), after reflecting from one surface only — for example, from the ceiling or a wall. These reflections fall into specific patterns for any particular environment, and provide vital information to our ears. Early reflections actually add clarity to the direct sound.

Reverberations

These are caused by reflections from more than one surface — walls, ceiling, the back of the room — so numerous that they merge together to form a continuous sonic “afterglow”. They are non-directional, and lessen the clarity of the direct sound.

Direct sound, early reflections and subsequent reverberation taken together help us to determine the subjective size and shape of the room, and it is this information that the digital sound field processor reproduces in order to create sound fields.

If you could create the appropriate early reflections and subsequent reverberations in your listening room, you would be able to create your own listening environment. The acoustics in your room could be changed to those of a concert hall, a dance floor, or virtually any size room at all. This ability to create sound fields at will is exactly what YAMAHA has done with the digital sound field processor.

Sound Field Program Parameters

DSP programs consist of some parameters to determine the apparent room size, reverberation time, distance from you to the performer, etc. In each program, these parameters are set with values precisely calculated by YAMAHA to create a sound field unique to the program. It is recommended to use DSP programs without changing the values of parameters; however, this unit also allows you to create your own sound fields. Starting with one of the built-in programs, you can adjust those parameters.

Each DSP program has a set of parameters that allow you to change the characteristics of the acoustic environment to precisely create the effect you want. These parameters correspond to the many natural acoustic factors that create the sound field you experience in an actual concert hall or other listening environment. The size of the room, for example, affects the length of time between the early reflections. The “ROOM SIZE” parameter provided in many of the DSP programs alters the timing between these reflections, thus changing the shape of the “room” you are listening. In addition to room size, the shape of the room and the characteristics of its surfaces have a significant effect on the final sound. Surfaces that absorb sound, for example, cause the reflections and reverberations to die out more quickly, while highly reflective surfaces allow the reflections to carry on for a longer period of time. The digital sound field parameters allow you to control these and many other factors that contribute to your personal sound field, allowing you to essentially “redesign” the concert halls, theaters, etc. provided to create custom-tailored listening environments that ideally match your mood and music.

See “Sound Field Parameter Descriptions”.

Changing Parameter Settings

Although it is possible to enjoy playback on your system without changing default setting parameters for the sound field program, it is also possible to enjoy specifically tailor the sound field program to the characteristics of the source and the acoustics of the listening room.

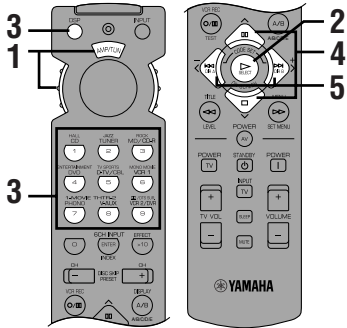

1 Set the selector dial to the DSP/TUN (or AMP/TUN) position.

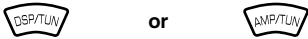

2 Turn on the video monitor and press ON SCREEN repeatedly to select the full display mode.

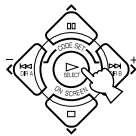

3 Select a DSP program you want to adjust.

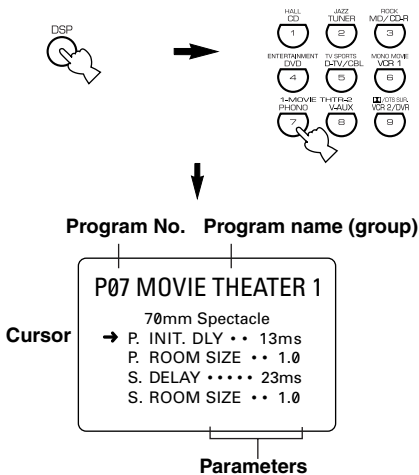

Example of the MOVIE THEATER 1

4 Press \swarrow to select the parameter.

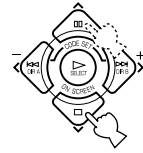

5 Press \langle / \rangle to change the parameter value.

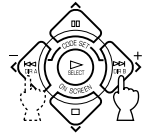

• When you set the parameter to a value other than the factory-set value, an asterisk mark (*) appears by the parameter name on the video monitor.

6 Repeat steps 3 to 5 above as necessary to change other program parameters.

Memory back-up

The memory back-up circuit prevents the stored data from being lost even if this unit is set in the standby mode, the power cord is disconnected from the AC outlet, or the power supply is temporarily cut due to power failure. However, if the power is cut for more than one week, the parameter value you edited will return to the factory setting. If so, edit the parameter value again.

Resetting a Parameter to the Factory-set Value

Select the parameter you want to reset. Then press and hold \langle or \rangle until the value temporarily stops at the factory-set value. The asterisk mark (*) by the parameter name disappears on the video monitor.

Notes

- The available parameters may be displayed on more than one OSD page for some of the programs. To scroll through pages, press \swarrow .
- You cannot change parameter values when “10 MEMORY GUARD” on the SET MENU is set to ON. If you want to change the parameter values, set “10 MEMORY GUARD” to OFF.

Sound Field Parameter Descriptions

You can adjust the values of certain sound field parameters so the sound fields are recreated accurately in your listening room.

Note

- Not all of the following parameters can be found in every program.

■ INIT.DLY (initial delay) (P.INIT.DLY — for the presence sound field)

Function: This parameter changes the apparent distance from the sound source by adjusting the delay between the direct sound and the first reflection heard by the listener.

Control range: 1 – 99 msec

Description: The smaller the value, the closer the sound source seems to the listener. The larger the value, the farther the apparent distance seems. For a small room, this parameter would be set to a small value, for a large room, set it to a large value.

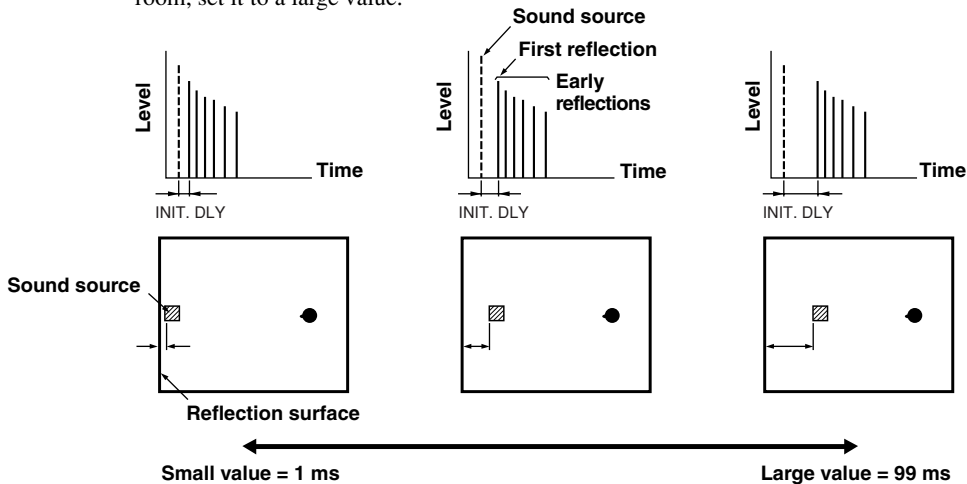

■ ROOM SIZE (P.ROOM SIZE — for the presence sound field)

Function: This parameter adjusts the apparent size of the surround sound field. The larger the value, the larger the surround sound field becomes.

Control range: 0.1 – 2.0

Description: As the sound is repeatedly reflected around a room, the larger the hall is, the longer the time between the original reflected sound and the subsequent reflections. By controlling the time between the reflected sounds, you can change the apparent size of the virtual venue. Changing this parameter from one to two, doubles the apparent length of the room.

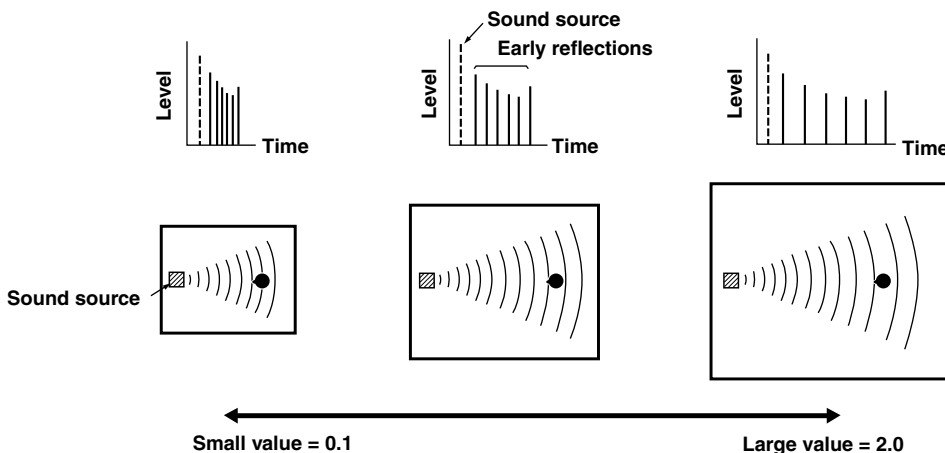

■ LIVENESS

Function: This parameter adjusts the reflectivity of the virtual walls in the hall by changing the rate at which the early reflections decay.

Control range: 0 – 10

Description: The early reflections of a sound source decay much faster in a room with acoustically absorbent wall surfaces than in one which has highly reflective surfaces. A room with acoustically absorbent surfaces is referred to as “dead,” while a room with highly reflective surfaces is referred to as “live”. The “LIVENESS” parameter lets you adjust the early reflection decay rate, and thus the “liveness” of the room.

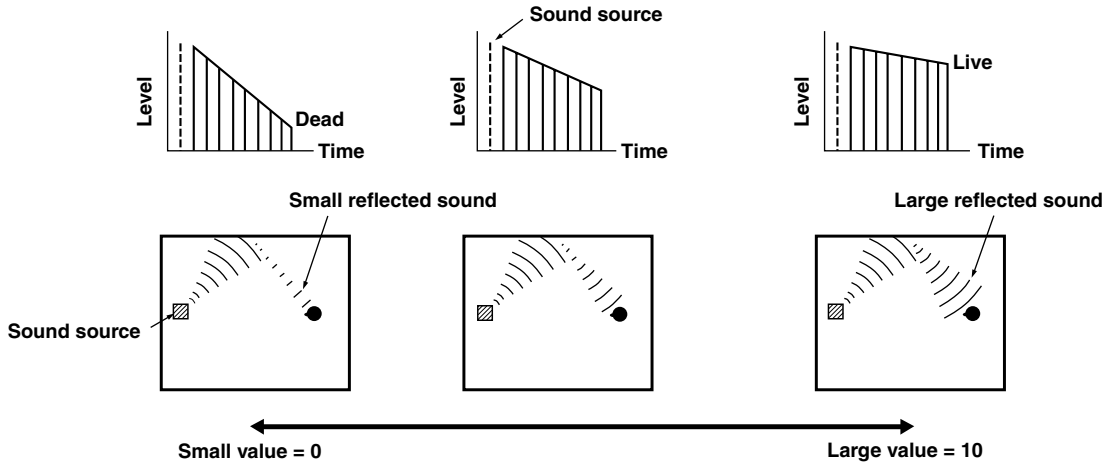

■ S.DELAY (surround delay)

Function: This parameter adjusts the delay between the direct sound and the first reflection in the surround sound field.

Control range: 0 – 49 msec (The range depends on the signal format.)

■ S.INIT.DLY (surround initial delay)

Function: This parameter adjusts the delay between the direct sound and the first reflection on the surround side of the sound field. You can only adjust this parameter when at least two front channels and two rear channels are used.

Control range: 1 – 49 msec

■ **S.ROOM SIZE (surround room size)**

Function: This parameter adjusts the apparent size of the surround sound field.

Control range: 0.1 – 2.0

■ **S.LIVENESS (surround liveness)**

Function: This parameter adjusts the apparent reflectivity of the virtual walls in the surround sound field.

Control range: 0 – 10

■ **CT.DELAY (center delay)**

Function: These parameters adjust the sound delay for each channel in 5 channel stereo mode.

Control range: 0 – 50 msec

■ **LS.DELAY (left surround delay)**

Function: These parameters adjust the sound delay for each channel in 5 channel stereo mode.

Control range: 0 – 50 msec

■ **RS.DELAY (right surround delay)**

Function: These parameters adjust the sound delay for each channel in 5 channel stereo mode.

Control range: 0 – 50 msec

TROUBLESHOOTING

Refer to the chart below when the unit does not function properly. If the problem you are experiencing is not listed below or if the instruction below does not help, set this unit in the standby mode, disconnect the power cord and contact the nearest authorized YAMAHA dealer or service center.

■ General

| Problem | Cause | Remedy | Refer to page |
|--|---|--|---------------|
| The unit fails to turn on when STANDBY/ON (or POWER) is pressed, or enters in the standby mode soon after the power has been turned on. | The power cord is not connected or the plug is not completely inserted. | Firmly connect the power cord. | 19 |
| | The IMPEDANCE SELECTOR switch on the rear panel is not fully set to the left or right position. | Set the switch fully to the left or right position when the unit is in the standby mode. | 19 |
| | The protection circuitry has been activated. | Make sure all speaker wire connections on this unit and on all speakers are secure and that the wire for each connection does not touch anything other than its respective connection. | 16, 17 |
| On-screen display does not appear. | The setting for the on-screen display is set to "DISPLAY OFF". | Select the full display or short display mode. | 20 |
| | The BLUE BACK setting under "9 DISPLAY SET" on the SET MENU is set to OFF, and no video signal is input to this unit. | Set BLUE BACK to AUTO to always show the OSD. | 37 |
| No sound and/or no picture. | Incorrect input or output cable connections. | Connect the cables properly. If the problem persists, the cables may be defective. | 12 – 15 |
| | An appropriate input source has not been selected. | Select an appropriate input source with INPUT < /> or 6CH INPUT (or the input selector buttons). | 24 |
| | The speaker connections are not secure. | Secure the connections. | 16, 17 |
| | The main speakers to be used have not been selected properly. | Select the main speakers with SPEAKERS A and/or B. | 24 |
| | The volume is turned down. | Turn up the volume. | 25 |
| | The sound is muted. | Press MUTE or any operation buttons to cancel a mute and adjust the volume. | 25 |
| | Digital signals other than PCM audio, Dolby Digital or DTS signal which this unit cannot reproduce are being input to this unit by playing a CD-ROM, etc. | Play a source whose signals this unit can reproduce. | — |
| The picture does not appear. | The output and input for the video are connected to different types of video jacks. | Make connections using the same type of jack (between composites, S-VIDEOS, or components) for both the input and output. | 14, 15 |
| The sound suddenly goes off. | The protection circuit has been activated because of a short circuit, etc. | Check the IMPEDANCE SELECTOR switch is set to the appropriate position and then turn the unit back on. | 19 |
| | | Check the speaker wires are not touching each other and then turn the unit back on. | 16, 17 |
| | The sleep timer has functioned. | Turn on the power, and play the source again. | 39 |
| | The sound is muted. | Press MUTE or any operation buttons to cancel a mute and adjust the volume. | 25 |
| Only the speaker on one side can be heard. | Incorrect cable connections. | Connect the cables properly. If the problem persists, the cables may be defective. | 12 – 17 |

| Problem | Cause | Remedy | Refer to page |
|--|--|--|----------------------|
| No sound from the effect speakers. | The sound effect is off. | Press EFFECT to turn it on. | 29 |
| | A Dolby Surround, Dolby Digital or DTS decoding DSP program is being used with material not encoded with Dolby Surround, Dolby Digital or DTS. | Select another DSP program. | 47, 48 |
| | A 96-kHz sampling digital signal is being input to this unit. | | 25 |
| No sound from the center speaker. | The output level of the center speaker is set to minimum. | Raise the level of the center speaker. | 38 |
| | “1A CENTER SP” on the SET MENU is set to NONE. | Select the appropriate mode for your center speaker. | 32 |
| | One of the Hi-Fi DSP programs (1 to 4) has been selected. | Select another DSP program. | 47, 48 |
| | The source encoded with a Dolby Digital or DTS signal does not have a center channel signal. | | — |
| No sound from the rear speakers. | The output level of the rear speakers is set to minimum. | Raise the output level of the rear speakers. | 38 |
| | A monaural source is being played with the program 9. | Select another DSP program. | 47, 48 |
| No sound from the subwoofer. | “1D LFE/BASS OUT” on the SET MENU is set to MAIN when a Dolby Digital or DTS signal is being played. | Select SWFR or BOTH. | 34 |
| | “1D LFE/BASS OUT” on the SET MENU is set to SWFR or MAIN when a 2-channel source is being played. | Select BOTH. | 34 |
| | The source does not contain low bass signals (90 Hz and below). | | — |
| Poor bass reproduction. | “1D LFE/BASS OUT” on the SET MENU is set to SWFR or BOTH and your system does not include a subwoofer. | Select MAIN. | 34 |
| | The output mode for each speaker (main, center or rear) on the SET MENU does not match your speaker configuration. | Select the appropriate output mode for each speaker based on the size of the speakers in your configuration. | 32, 33 |
| A “humming” sound can be heard. | Incorrect cable connections. | Firmly connect the audio plugs. If the problem persists, the cables may be defective. | 12 – 15 |
| | No connection from the turntable to the GND terminal. | Connect the grounding cord of your turntable to the GND terminal of this unit. | 12, 13 |
| The volume level is low while playing a record. | The record is being played on a turntable with an MC cartridge. | The turntable should be connected to the unit through an MC-head amplifier. | 12 |

| Problem | Cause | Remedy | Refer to page |
|---|---|--|---------------|
| The volume level cannot be increased, or the sound is distorted. | The component connected to the REC OUT jacks of this unit is turned off. | Turn on the power to the component. | 12 |
| The effect and surround sounds cannot be recorded. | It is not possible to record the effect and surround sounds by a recording component. | | 30 |
| A source cannot be recorded by a digital recording component connected to the DIGITAL OUTPUT jack of this unit. | A source component is only connected to the analog input jacks of this unit. | Connect the source component to the digital input jacks of this unit. | 12 – 15 |
| The sound field parameters and some other settings on this unit cannot be changed. | “10 MEMORY GUARD” on the SET MENU is set to ON. | Select OFF. | 37 |
| This unit does not operate properly. | The internal microcomputer has been frozen by an external electric shock (such as lightning or excessive static electricity) or by a power supply with low voltage. | Disconnect the AC power cord from the outlet and then plug it in again after about 30 seconds. | — |
| The sound is degraded when listening with headphones connected to a tape deck or CD player that is connected to this unit. | This unit is in the standby mode. | Turn on the power of the unit. | — |
| There is noise interference from digital or high-frequency equipment, or the unit. | The unit is too close to the digital or high-frequency equipment. | Move the unit further away from such equipment. | — |

■ Remote control

| Problem | Cause | Remedy | Refer to page |
|---|---|---|---------------|
| The remote control does not work nor function properly. | Wrong distance or angle. | The remote control will function within a maximum range of 6 m (20 feet) and no more than 30 degrees off-axis from the front panel. | 8 |
| | Direct sunlight or lighting (from an inverter type of fluorescent lamp, etc.) is striking the remote control sensor of this unit. | Reposition the unit. | — |
| | The batteries are weak. | Replace all batteries with new ones. | 3 |
| The unit or other component cannot be controlled. | The component to be controlled has not been selected. | Set the selector dial to the appropriate position, corresponding to the component to be controlled. | 40 |
| | The remote control cannot control system components. | | — |
| | The manufacturer code has not been set up properly. | Enter the code again. | 45 |
| | | Try setting another code for the same manufacturer. | |
| Depending on the manufacturer or the model, some components cannot be controlled with this unit's remote control even though the code has been set up properly. | Use the original remote control supplied with your component. | — | |

After this unit has been exposed to a strong external electric shock (such as lightning and strong static electricity) or if you mishandle the operation of this unit, it may not function properly. In these cases, set this unit in the standby mode, disconnect the power cord, plug it back in after 30 seconds, and start operating.

SPECIFICATIONS

AUDIO SECTION

- Minimum RMS Output Power for Main, Center, Rear
 20 Hz to 20 kHz, 0.06% THD, 8 ohms 90 W
 1 kHz, 0.06% THD, 8 ohms 100 W
- DIN Standard Output Power
 [Europe model only]
 1 kHz, 0.7% THD, 4 ohms 130 W
- IEC Output Power
 [Europe model only]
 1 kHz, 0.06% THD, 8 ohms 100 W
- Maximum Power (EIAJ)
 [China and General models only]
 1 kHz, 10% THD, 8 ohms 115 W
- Dynamic Power (IHF)
 8/6/4/2 ohms 120/140/175/210 W
- Damping Factor
 20 Hz to 20 kHz, 8 ohms 80 or more
- Frequency Response
 CD to Main L/R 10 Hz to 100 kHz, -3 dB
- RIAA Equalization Deviation
 PHONO (MM) ±0.5 dB
- Total Harmonic Distortion
 PHONO MM (20 Hz to 20 kHz, 1 V, REC OUT) 0.02% or less
 CD, etc. (20 Hz to 20 kHz, 45 W, 8 ohms, Main L/R)
 0.06% or less
- Signal to Noise Ratio (IHF-A Network)
 PHONO MM to REC OUT (5 mV, shorted)
 [Europe and U.K. models] 81 dB or more
 [China and General models] 86 dB or more
 CD (250 mV, shorted) to Main L/R, Effect Off 100 dB or more
- Residual Noise (IHF-A Network)
 Main L/R 150 µV or less
- Channel Separation (1 kHz/10 kHz)
 CD (5.1 kohms terminated) to Main L/R 60 dB/45 dB
- Tone Control (Main L/R)
 BASS Boost/Cut ±10 dB/50 Hz
 TREBLE Boost/Cut ±10 dB/20 kHz
 BASS EXTENSION +6 dB/60 Hz
- Phones Output 400 mV/560 ohms
- Input Sensitivity
 CD, etc 150 mV/47 kohms
 PHONO 2.5 mV/47 kohms
 6CH INPUT 150 mV/47 kohms
- Maximum Input Signal
 PHONO MM (1 kHz, 0.1% THD) 100 mV or more
 CD, etc. (1 kHz, 0.5% THD) 2.2 V or more
- Output Level
 REC OUT 150 mV/1.2 kohms
 PRE OUT [Europe and U.K. models only] 2.1 V/1.2 kohms
 SUBWOOFER 4.0 V/1.2 kohms

VIDEO SECTION

- Video Signal Type
 [Europe and U.K. models] PAL
 [China and General models] NTSC
- Composite Video Signal Level 1 Vp-p/75 ohms
- S-Video Signal Level
 Y 1 Vp-p/75 ohms
 C 0.286 Vp-p/75 ohms
- Component Video Signal Level
 Y 1 Vp-p/75 ohms
 Pb/Cb, Pr/Cr 0.7 Vp-p/75 ohms
- Signal to Noise Ratio 50 dB or more
- Frequency Response (MONITOR OUT)
 Composite, S-Video 5 Hz to 10 MHz, -3 dB
 Component DC to 30 MHz, -3 dB

GENERAL

- Power Supply
 [Europe and U.K. models] AC 230 V/50 Hz
 [China model] AC 220 V/50 Hz
 [General model] AC110/120/220/240 V, 50/60 Hz
- Power Consumption 260 W
 Standby Mode [Europe and U.K. models] 0.9 W
- Maximum Power Consumption
 [General model only]
 5-ch, 10% THD 610 W
- AC Outlets (Total 100 W maximum)
 [Europe, China and General models] 2 (SWITCHED)
 [U.K. model] 1 (SWITCHED)
- Dimension (W x H x D) 435 x 151 x 390 mm
- Weight 10.5 kg
- Accessories Remote Control
 Batteries
 Quick Reference Card
 Connection Guide

* Specifications are subject to change without notice.

GLOSSARY

■ Dolby Surround

Dolby Surround uses a four analog channel recording system to reproduce realistic and dynamic sound effects: two left and right main channels (stereo), a center channel for dialog (monaural), and a rear channel for special sound effects (monaural). The rear channel reproduces sound within a narrow frequency range.

Dolby Surround is widely used with nearly all video tapes and laser discs, and in many TV and cable broadcasts as well. The Dolby Pro Logic decoder built into this unit employs a digital signal processing system that automatically stabilizes the volume on each channel to enhance moving sound effects and directionality.

■ Dolby Digital

Dolby Digital is a digital surround sound system that gives you completely independent multi-channel audio. With three front channels (left, center and right), and two rear stereo channels, Dolby Digital provides five full-range audio channels. With an additional channel especially for bass effects, called LFE (low frequency effect), the system has a total of 5.1 channels (LFE is counted as 0.1 channel).

Using two-channel stereo for the rear speakers, more accurate moving sound effects and surround sound environment are possible than with Dolby Surround. The wide dynamic range (from maximum to minimum volume) reproduced by the five full-range channels and the precise sound orientation generated using digital sound processing provide listeners with previously unheard of excitement and realism.

With this unit, any sound environment from monaural up to a 5.1-channel configuration can be freely selected for your enjoyment.

■ DTS (Digital Theater Systems) Digital Surround

DTS digital surround was developed to replace the analog soundtracks of movies with a six-channel digital sound track, and is now rapidly gaining popularity in movie theaters around the world. Digital Theater Systems Inc. has developed a home theater system so that you can enjoy the depth of sound and natural spatial representation of DTS digital surround in your home. This system is practically distortion-free, clear 6-channel sound (technically, a left, right and center channels, two rear channels, plus an LFE 0.1 channel as a subwoofer, for a total of 5.1 channels).

■ LFE 0.1 channel

This channel is for the reproduction of low bass signals. The frequency range for this channel is 20 Hz to 120 Hz. This channel is counted as 0.1 because it only enforces a low frequency range compared to the full-range reproduced by the other 5 channels in a Dolby Digital or DTS 5.1 channel systems.

■ CINEMA DSP

Since the Dolby Surround and DTS systems were originally designed for use in movie theaters, their effect is best felt in a theater having many speakers and designed for acoustic effects. Since home conditions, such as room size, wall material, number of speakers, and so on, can differ so widely, it's inevitable that there are differences in the sound heard as well. Based on a wealth of actually measured data, YAMAHA CINEMA DSP uses YAMAHA original sound field technology to combine Dolby Pro Logic, Dolby Digital and DTS systems to provide the visual and audio experience of movie theater in the listening room of your own home.

■ SILENT CINEMA

YAMAHA has developed a natural, realistic sound effect DSP algorithm for headphones.

Parameters for headphones have been set for each sound field so that accurate representations of all the sound field programs can be enjoyed on headphones.

■ Virtual CINEMA DSP

YAMAHA has developed a virtual CINEMA DSP algorithm that allows you to enjoy DSP sound field surround effects even without any rear speakers by using virtual rear speakers.

It is even possible to enjoy virtual CINEMA DSP in a minimum two-speaker system that does not include a center speaker.

■ S VIDEO signal

With S VIDEO signal system, the video signal normally transmitted using a pin cable is separated and transmitted as the Y signal for the luminance and the C signal for the chrominance through the S VIDEO cable. Using the S VIDEO jack eliminates video signal transmission loss and allows recording and playback of even more beautiful images.

■ Component video signal

With the component video signal system, the video signal is separated into the Y signal for the luminance and the P_B/C_B and P_R/C_R signals for the chrominance. Color can be reproduced more faithfully with this system because each of these signals is independent. The component signal is also called the “color difference signal” because the luminance signal is subtracted from the color signal. A monitor with component input jacks is required in order to use the component signal for output.

■ PCM (Linear PCM)

Linear PCM is a signal format under which an analog audio signal is digitized, recorded and transmitted without using any compression. This is used as a method of recording CDs and DVD audio. The PCM system uses a technique for sampling the size of the analog signal per very small unit of time. Standing for “pulse code modulation”, the analog signal is encoded as pulses and then modulated for recording.

■ Sampling frequency and number of quantized bits

When digitizing an analog audio signal, the number of times the signal is sampled per second is called the sampling frequency, while the degree of fineness when converting the sound level into a numeric value is called the number of quantized bits.

The range of rates that can be played back is determined based on the sampling rate, while the dynamic range representing the sound level difference is determined by the number of quantized bits. In principle, the higher the sampling frequency, the wider the range of frequencies that can be played back, and the higher the number of quantized bits, the more finely the sound level can be reproduced.

■ I/O assignment (SET MENU)

Although component is normally connected according to jack names shown on the rear panel, this unit includes a function that assigns jacks according to the component being connected. If the component being used differs from the component name shown for this unit's component video input jacks or digital input/output jacks, it is possible to assign jacks according to the component being connected. This makes it possible to change the jack assignment and effectively connect more component.

INDEX

A

| | |
|-------------------|----|
| Accessories | 3 |
| AC outlets | 19 |

B

| | |
|--|----|
| Balance (L/R BALANCE) (SET MENU) | 34 |
| BGV function | 26 |

C

| | |
|---|--------|
| CBL/SAT position | 44 |
| CD position | 42 |
| CINEMA DSP | 47, 60 |
| Component video | 61 |
| Connections | |
| Audio components (MD recorder, CD recorder, CD player and turntable) | 12 |
| External amplifier (Europe and U.K. models only) | 18 |
| External decoder | 18 |
| Power supply cords | 19 |
| Speakers | 16 |
| Video components (DVD player, VCR and TV/digital TV or cable TV/satellite tuner) | 14 |

D

| | |
|--|----|
| Delay time | 37 |
| DISPLAY SET (SET MENU) | |
| BLUE BACK | 37 |
| DIMMER | 37 |
| OSD SHIFT | 37 |
| DOLBY D. SET (SET MENU) | |
| D-RANGE | 36 |
| LFE LEVEL | 36 |
| Dolby Digital | 60 |
| Dolby Surround (Dolby Pro Logic) | 60 |
| DSP program | |
| CINEMA DSP program | 47 |
| Hi-Fi DSP program | 47 |
| DTS | 60 |
| DTS SET (SET MENU) | 36 |
| Dust protection cap | 12 |
| DVD/LD position | 43 |
| DVD MENU position | 43 |

E

| | |
|------------------------|----|
| External decoder | 18 |
|------------------------|----|

F

| | |
|---------------------------|---|
| Front panel | 4 |
| Front panel display | 9 |

H

| | |
|-------------------------------|----|
| HP TONE CTRL (SET MENU) | 35 |
|-------------------------------|----|

I

| | |
|---------------------------------|--------|
| I/O ASSIGNMENT (SET MENU) | 35, 61 |
| IMPEDANCE SELECTOR switch | 19 |
| INPUT MODE (SET MENU) | 35 |
| Input modes | 26 |

L

| | |
|-----------|--------|
| LFE | 36, 60 |
|-----------|--------|

M

| | |
|-------------------------------|------------|
| Manufacturer codes | 45, i |
| Memory back-up | 32, 38, 51 |
| MEMORY GUARD (SET MENU) | 37 |
| Muting | 25 |

P

| | |
|--------------------------|----|
| PCM | 61 |
| PHONO jack | 12 |
| Playing | 24 |
| Power supply cords | 19 |

R

| | |
|-----------------------|----|
| Rear panel | 10 |
| Recording | 30 |
| Remote control | |
| Basic operation | 6 |
| Batteries | 3 |
| Operation range | 8 |
| Setup codes | 45 |

S

| | |
|----------------------------------|--------|
| Sampling frequency | 25, 61 |
| Selector dial | 6, 40 |
| SET MENU | 31 |
| SILENT CINEMA | 29, 60 |
| Sleep timer | 39 |
| Sound field | 50 |
| SP DELAY TIME (SET MENU) | 37 |
| Speaker | |
| Output balance (test tone) | 22 |
| Output levels (LEVEL mode) | 38 |
| Output mode (SET MENU) | 21 |
| Placement | 11 |
| SPEAKER SET (SET MENU) | |
| CENTER SP | 32 |
| LFE/BASS OUT | 34 |
| MAIN LEVEL | 34 |
| MAIN SP | 33 |
| REAR L/R SP | 33 |
| Stereo reproduction | 29 |
| Subwoofer | 17 |
| S VIDEO | 61 |

T

| | |
|-----------------------------------|----|
| TAPE/MD position | 42 |
| Test tone (TEST DOLBY SUR.) | 22 |
| TV position | 44 |

V

| | |
|--------------------------|--------|
| VCR position | 44 |
| Video jack | 14 |
| Virtual CINEMA DSP | 29, 60 |

**LIST OF MANUFACTURER'S CODES
LISTES DES CODES FABRICANT
VERZEICHNIS DER HERSTELLERCODES
LISTA ÖVER TILLVERKARKODER
ELENCO DEI CODICI DEL FABBRICANTE
LISTA DE CÓDIGOS DE FABRICANTES
LIJST VAN CODES VAN FABRIKANT**

| | | | | |
|-----------------------------|--|------------------------------|-----------------------------|--------------------------------|
| TV | | CLARIVOX 0821, 0961, 1971 | FIRST LINE 1981 | HITACHI 0001, 0011, 0031, |
| ADMIRAL 0411, 0451, 0911, | | CLATRONIC 1181, 1331 | FISHER 0021, 0091, 0141, | 0081, 0141, 0291, |
| 1021, 1081 | | CONCERTO 0791 | 0511, 0601, 0801, | 0331, 0341, 0451, |
| AIKO 0891 | | CONDOR 0761 | 0821, 0981, 1021, | 0601, 0631, 0701, |
| AKAI 0061, 0101, 0231, | | CONTEC 0151, 1171 | 1081, 1981, 2091 | 1281, 1561, 1601, |
| 1191, 1351, 1591, | | CONTINENTAL EDISON | FORGESTONE 2281 | 1821, 1831, 1841, |
| 1641, 1791, 1891, | | 0571, 0651, 0901 | FORMENTI 0451, 0491, 0761, | 1861, 1871, 1881, |
| 1981 | | CRAIG 1171 | 1081, 1451, 1541, | 1891, 1941, 1981, |
| AKURA 1331 | | CROSLEY 0021, 0491, 1021, | 1981 | 2051, 2321, 2341 |
| ALBA 1241, 1331, 2361 | | 1081, 1401, 1981, | FORMENTI-PHOENIX | HYPER 0591, 0601, 1511, |
| ALBIRAL 1971 | | 2201, 2251, 2271 | 0021, 0431, 0451, | 1621 |
| AMSTRAD 1301, 1511 | | CROWN 2541 | 0591, 1411 | IMPERIAL 0451, 0491, 0811, |
| ANAM 1171 | | CTC CLATRONIC 0261 | FORTRESS 1081 | 0981, 1401, 1611, |
| ARC EN CIEL 0571 | | CXC 1171 | FRONTECH 0451, 1181, 1981 | 1621, 2201, 2251, |
| ARCAM 0571, 0761 | | DAEWOO 0101, 1501, 1511, | FUJITSU 1261 | 2271 |
| ARISTONA 0751 | | 2611 | FUNAI 0391, 0691, 1171, | INGERSOL 1511 |
| ARTHUR MARTIN 0451, 1641 | | DANSAI 0101 | 1181, 1261 | INNO HIT 0581, 0601, 0841, |
| ASA 0411, 0451, 0521, | | DECCA 0271, 0581, 0601, | FUTURETECH 1171 | 1101, 1331, 1371, |
| 0781, 0871, 1021, | | 0971, 1101, 1691 | GBC 0021, 0141, 1321, | 1511, 2011 |
| 1081, 1421, 2051, | | DECCA (UK) 0271, 0581, 0601, | 1511, 1621, 1981 | INNOVATION 2591, 2601, 2611, |
| 2091, 2151, 2551 | | 1101, 1681 | GEC 0451, 1101, 1281, | 2621, 2641, 2651, |
| ASTRA 1511 | | DEGRAAF 0451, 1351 | 2321 | 2661, 2711, 2721, |
| ATANTIC 0761 | | DIXI 0991, 1511 | GEC (UK) 0031, 0081, 0581, | 2761, 2771, 2781 |
| ATLANTIC 0761 | | DOMEOS 0101 | 0601, 1101, 1281, | INTERFUNK 0031, 0041, 0061, |
| ATORI 1511 | | DORIC 1031 | 1561 | 0121, 0181, 0451, |
| AUDIOSONIC 1181, 1321, 1511 | | DUAL 0091, 0601, 1611, | GELOSO 0021, 0411, 0451, | 0491, 1081, 1641, |
| AUSIND 0491, 1411 | | 1641, 2101 | 1321, 1511, 1621, | 1791, 1821, 1981, |
| AUTOVOX 0091, 0351, 0481, | | DUAL-TEC 0601, 1511, 1621, | 1981 | 2231 |
| 0491, 0601, 0781, | | 2111 | GENERAL TECHNIC 2681 | IRRADIO 0491, 1321, 1331, |
| 0951, 1051, 1081, | | DUMONT 0261, 0521, 0781, | GENEXXA 0451, 1331 | 1371, 1411, 1511, |
| 1391, 1421 | | 1021, 1081, 1981, | GOLDSTAR 0591, 0601, 0761, | 2011 |
| BAIRD 1101, 1351 | | 2121, 2151 | 0791, 1371, 1491, | ISUKAI 1331 |
| BANG & OLUFSEN 1081 | | DYNATRON 0101 | 1511, 1561, 1621, | ITT 0031, 0041, 0051, |
| BASIC LINE 1321, 1331 | | ELBE 1551, 1971, 2031 | 1641 | 0061, 0071, 0081, |
| BAUER 1451 | | ELECTRO TECH 1511 | GOODMANS 0141, 1101, 1371, | 0181, 0411, 0451, |
| BAUR 0041, 0061, 0121, | | ELEKTRONSKA 0771 | 1641, 2301 | 0491, 1241, 1291, |
| 0131, 0221, 1561 | | ELMAN 0261, 1621 | GORENJE 0981, 1061 | 1351, 1501, 1601, |
| BEKO 2491, 2501 | | ELTA 1511 | GRAETZ 0451 | 1641, 1741, 1921, |
| BLAUPUNKT 0221, 0231, 0241, | | EMERSON 0921, 1021, 1081, | GRANADA 0141, 0451, 0491, | 1981, 2091, 2331, |
| 0251, 0471, 0741, | | 1121, 1171, 1261, | 0581, 0601, 1101, | 2431 |
| 2201, 2211, 2221, | | 1301 | 1111, 1351, 1981, | ITT-NOKIA 0031, 0041, 0051, |
| 2231, 2241, 2261, | | ERRES 0101 | 2321 | 0061, 0071, 0081, |
| 2571, 2581 | | ETRON 1981 | GRANADA (UK) 0081, 0141, | 0181, 0411, 0451, |
| BRANDT 0571, 0651, 0731, | | EUROPHON 0261, 0581, 0601, | 0451, 0491, | 0491, 1241, 1291, |
| 0901, 1821 | | 0771, 1091, 1621, | 0581, 0601, | 1351, 1501, 1601, |
| BRIONVEGA 1021, 1051, 1081 | | 2001 | 1031, 1311, | 1641, 1741, 1921, |
| BRITANNIA 0761 | | FENNER 0101, 1511 | 1521, 1561, | 1981, 2091, 2331, |
| BRUNS 0821, 0991, 1021, | | FERGUSON 0281, 0371, 0551, | 1641 | 2431 |
| 1081 | | 0651, 0781, 0861, | GRUNDIG 0221, 0231, 0471, | JVC (VICTOR) 0071, 0721, 1441, |
| BSR 0391, 0691, 1621, | | 0881, 1131, 1181, | 0491, 0711, 0741, | 1581, 1591, 1741, |
| 1901, 1981 | | 1361, 1461, 1971, | 1381, 2021, 2041, | 1791 |
| BUSH 0451, 1241, 1331, | | 1991, 2281, 2311, | 2141, 2151 | KAISUI 0591, 1321, 1331 |
| 1641, 1741, 2131, | | 2341 | HANSEATIC 0021, 0121, 0141, | KAMOSONIC 0601 |
| 2151 | | FIDELITY 0451, 0761, 2281 | 0431, 0591, 1561 | KARCHER 0591, 0601, 0841, |
| BUSH (UK) 0481, 1561, 1611 | | FIDELITY (UK) 0561, 0591, | HANTAREX 0581 | 1091, 1321, 1511, |
| CANDLE 0791 | | 1931, 2281 | HEMMERMANN 0061 | 1561, 2051 |
| CENTURY 1021, 1081 | | FILMNET 1141 | HIFIVOX 0331, 0571 | KAWASHO 0761 |
| CGE 0491, 0811, 0981, | | FINLANDIA 0451, 2321 | HINARI 0071, 0141, 0451, | KENDO 0261 |
| 1401, 1531, 1611, | | FINLUX 0021, 0261, 0491, | 1261, 1351, 1511, | KENNEDY 0021, 0351, 0951, |
| 1621, 1981, 2201, | | 0521, 0781, 0811, | 1641, 1981, 2011 | 1981 |
| 2251, 2271 | | 0871, 1081, 1411, | | 2701 |
| CITIZEN 0791 | | 1421, 1981, 2051, | | KONKA 0431, 1011, 1021, |
| | | 2091, 2121, 2151, | | 1081, 1541 |
| | | 2551 | | |

| | | | | | | | |
|---------------------|-------------------|-------------------|-------------------|------------------|-------------------|------------|-------------------|
| KTV | 0601, 1171 | NECKERMANN | 0451, 0601, | PRIMA | 0451 | SELECO | 0071, 0101, 0351, |
| LENOIR | 0601, 1511 | | 0981, 1081, | PROFEX | 1981 | | 0411, 0451, 0951, |
| LEYEO | 1181 | | 1561, 1931, | PROTECH | 0641, 1181, 1981 | | 1901, 2061, 2101, |
| LIFETEC | 2591, 2601, 2611, | | 1981, 2211, | QUELLE | 0041, 0061, 0121, | SENTRA | 2111 |
| | 2621, 2641, 2651, | | 2231, 2241 | | 0221, 0231, 0391, | SHARP | 1601 |
| | 2661, 2671, 2681, | NEDIATOR | 0101 | | 0491, 0521, 0601, | | 0141, 0151, 0191, |
| | 2691, 2711, 2761, | NICAMAGIC | 0761 | | 0781, 1371, 1381, | | 1761, 1781 |
| | 2771, 2781 | NIKKAJ | 1101, 1331, 1641, | | 1411, 1421, 1641, | SIAREM | 0021, 0261, 0581, |
| LOEWE OPTA | 0121, 0131, 0581, | | 1701, 2011 | | 1681, 2051, 2091, | | 0641, 1021, 1081, |
| | 0611, 1081 | NOBLIKO | 0261, 0491, 0591, | | 2141, 2151, 2201, | | 1981 |
| LOGIC | 1691, 2281 | | 0641, 1381, 1411 | | 2211, 2231, 2241, | SICATEL | 1971 |
| LOGIK | 0551, 1681, 2281 | NOGAMATIC | 0571 | | 2251, 2271, 2551, | SIEMENS | 0151, 0221, 0231, |
| LOWEWE | 0831 | NOKIA | 0031, 0041, 0051, | | 2571, 2581 | | 0451, 0741, 2011, |
| LUMA | 0351, 0451, 1901 | | 0061, 0071, 0081, | REDIOMARELLI | 0101, 0451, | | 2201, 2211, 2221, |
| LUXMAN | 0791 | | 0181, 0411, 0451, | | 0661, 0771, | | 2231, 2241, 2261, |
| LUXMAN STEREO TUNER | | | 0491, 1241, 1291, | | 1081 | | 2571, 2581 |
| | 0791 | | 1351, 1501, 1601, | RADIONETTE | 0031, 2051, 2091 | SILVER | 1181 |
| LUXOR | 0001, 0061, 0181, | | 1641, 1741, 1921, | RADIOLA | 2291 | SINGER | 0021, 0261, 1021, |
| | 0341, 0421, 0451, | | 1981, 2091, 2331, | RANK | 0481, 2151 | | 1081 |
| | 0461, 0491, 0601, | | 2431, 2461, 2791 | RBM | 2131, 2151 | SINUDYNE | 0021, 0061, 0101, |
| | 0671, 1351, 1371, | NORDMENDE | 0031, 0291, 0331, | RBM (UK) | 0481 | | 0261, 0391, 0641, |
| | 1561, 1601, 1911, | | 0451, 0531, 0541, | REDIFFUSION | 0451, 0661, 1641, | | 0691, 0851, 0941, |
| | 1921, 1981 | | 0571, 1051, 1131, | | 1981, 2331 | | 1021, 1081, 1241, |
| LYCO | 1181 | | 1591, 1791, 1811, | REDIFFUSION (UK) | 0061, 0081, | | 1301, 1321, 1481, |
| MAGNADYNE | 0021, 0061, 0261, | | 1821, 1891, 1941, | | 1031 | | 1631, 1981 |
| | 0581, 0641, 0771, | | 2631 | REX | 0071, 0101, 0351, | SKANTIC | 0451 |
| | 1021, 1081, 1621, | OCEANIC | 0321, 1651, 1981 | | 0411, 0451, 0951, | SOLAVOX | 0451, 1641, 2011 |
| | 1981 | OCEANIC (F) | 0031, 0061, 0321, | | 1901, 2061, 2101, | SONOKO | 0101, 1181, 1511 |
| MAGNAFON | 0261, 0491, 0581, | | 0441, 1661 | | 2111 | SONY | 0141, 0171, 1121, |
| | 0591, 0641, 0761, | ONCEAS | 0601 | RFT | 0991, 2511 | | 1681, 1691, 2751 |
| | 1091, 2001 | ONWA | 1171 | ROADSTAR | 1321, 1511 | SOUNDESIGN | 1171 |
| MANESTH | 0101 | ORION | 0061, 0391, 0691, | ROTEL | 0151 | SSS | 1171 |
| MARANTZ | 0101 | | 0851, 1211, 1241, | SABA | 0291, 0331, 0421, | STERN | 0071, 0101, 0351, |
| MARELLI | 1081 | | 1251, 1301, 1481, | | 0451, 0531, 0541, | | 0411, 0451, 0951, |
| MARK | 0101 | | 1511, 1681, 1691, | | 0571, 0581, 0651, | | 1901, 2061, 2101, |
| MATSUI | 0061, 0451, 0601, | | 1981, 2371, 2421 | | 0731, 0931, 1021, | | 2111 |
| | 0691, 1101, 1151, | OSAKA | 2011 | | 1071, 1081, 1131, | SUNKAI | 0691 |
| | 1241, 1271, 1301, | OSAKI | 1101, 1331, 2011 | | 1791, 1811, 1821, | SUPRA | 0791 |
| | 1511, 1561, 1681, | OSUME | 0151 | | 1891, 1941, 2631 | TANDBERG | 0161, 0331, 0611, |
| | 1691 | OTTO VERSAND | 0021, 0121, | SACCS | 1971 | | 1021, 1421, 1771, |
| MAXIMAL | 0071, 1981 | | 0141, 0221, | SAISHO | 0451, 0601, 1161, | | 1791, 2081 |
| MCMICHAEL | 1281 | | 0601, 1561, | | 1241, 1301, 1511, | TANDY | 0191, 0451, 1331, |
| MEDION | 2591, 2601, 2611, | | 1741, 1981 | | 1671, 1681, 1691 | | 1531 |
| | 2621, 2641, 2651, | PAEL | 0591, 1411 | SALORA | 0011, 0041, 0061, | TASHIKO | 0141 |
| | 2661, 2671, 2681, | PANASONIC | 0031, 0201, 0211, | | 0071, 0341, 0451, | TATUNG | 0271, 0581, 0601, |
| | 2691, 2711, 2721, | | 0451, 0701, 1311, | | 0671, 1291, 1351, | | 0971, 1101, 1681, |
| | 2761, 2771, 2781 | | 1751, 1961, 2561, | | 1521, 1561, 1601, | | 1691 |
| MEMOREX | 1511 | | 2741 | | 1641, 1911, 1921, | TCM | 2621, 2641, 2711, |
| METZ | 0231, 0741, 1001, | PANORAMIC | 2351 | | 1931, 1981, 2321 | | 2761, 2771, 2781 |
| | 1041, 1081, 1481, | PATHE MARCONI | 0571 | SAMBERS | 0261, 0491, 0581, | TECHNICS | 1311 |
| | 2071, 2081 | PATHE' CINEMA (F) | 0431, 0591, | | 0641, 1091, 1371, | TECHWOOD | 0791 |
| MGA | 1231 | | 1621, 1661, | | 1411, 2001 | TEKNIKA | 1171, 1231, 1261 |
| MICROMAXX | 2591, 2621, 2641, | | 1971 | SAMSUNG | 0101, 0601, 0841, | TELE | 1141 |
| | 2651, 2711, 2761, | PAUSA | 1511 | | 0981, 1101, 1181, | TELEAVIA | 0571, 0651, 0731, |
| | 2771, 2781 | PAUZA | 1511 | | 1371, 1511, 2011 | | 1821 |
| MINERVA | 0221, 0231, 0491, | PERDIO | 0891, 1101 | SANYO | 0141, 0151, 0401, | TELEFUNKEN | 0291, 0301, 0311, |
| | 1381, 2141, 2151 | | 0021, 0491, 0811, | | 0601, 0801, 0821, | | 0551, 0731, 1131, |
| MISTRAL | 2281 | PHILCO | 0981, 1021, 1081, | | 0981, 1021, 1101, | | 1471, 1591, 1791, |
| MITSUBISHI | 0141, 0201, 0231, | | 1401, 1611, 1621, | | 1111, 1291, 1351, | | 1801, 1811, 1821, |
| | 0661, 1191, 1201, | | 1751, 2201, 2251, | | 1691, 1741, 2051, | | 1991, 2161, 2171, |
| | 1231, 1671, 1691, | | 2271, 2451, 2471 | | 2091, 2551 | | 2181, 2191, 2201, |
| | 1741 | PHILIPS | 0101, 0361, 0591, | SBR | 0681, 0751, 1281, | | 2251, 2271, 2521, |
| MIVAR | 0491, 0501, 0581, | | 0621, 0681, 0751, | | 2281 | | 2631 |
| | 0591, 0761, 0771, | | 0761, 1021, 1081, | SCHAUB LORENZ | 0451 | TELETECH | 1511 |
| | 1371, 1431, 2031 | | 1281, 2031, 2281, | SCHNEIDER | 0021, 0071, 0091, | TEMPEST | 2381, 2391, 2401, |
| MTC | 0791 | | 2291, 2431, 2441, | | 0451, 0511, 0591, | | 2411 |
| MULTITECH | 0261, 0581, 0601, | | 2511, 2731 | | 0601, 0751, 1321, | TENSAI | 1331, 2091 |
| | 0641, 0981, 1321, | PHOENIX | 1081 | | 1361, 1621, 1641, | TEXET | 0601 |
| | 1511 | PHONOLA | 0751, 1081 | | 2101, 2111, 2291 | THOMSON | 0331, 0481, 0531, |
| MURPHY | 0451, 2091 | PIONEER | 0291, 0451, 1341, | SCOTT | 1171, 1261 | | 0571, 0631, 0651, |
| MURPHY (UK) | 0081, 1031 | | 1821 | SEG | 0261, 0601, 0821, | | 0731, 0901, 1241, |
| N.E.I. | 0101, 0961 | | | | 0991 | | 1571, 1591, 1791, |
| NAD | 1341 | PRANDONI-PRINCE | 0411, 0451, | SEI | 0641, 0691, 1081, | | 1811, 1821, 1891, |
| NEC | 0141, 1711, 1721, | | 0491, 0581, | | 1301, 1481, 1981 | | 1941, 2531 |
| | 1731 | PRANDONI-PROMCE | 1411 | | | THORN | 0741, 0861, 2091, |
| | | | 0451, 0491, 0581 | | | | 2251, 2271, 2281 |

THORN-FERGUSON 0281, 0371,
0551, 0651,
0781, 0861,
0881, 1131,
1181, 1361,
1461, 1971,
1991, 2281
TMK 0141, 0791, 1471
TOSHIBA 0141, 0381, 0481,
1221, 1271, 1701,
1741, 1851, 2151,
2801, 2811
TRANS CONTINENS
0451
TRISTAR 2281
TRIUMPH 0481, 0581, 2121
UHER 0431, 0451, 0481,
0491, 0511, 1311,
1541
ULTRAVOX 0021, 0261, 0591,
1021, 1081, 1981
UNIVERSUM 1181, 2051
UNIVOX 1971
VEGAVOX 0811
VEXA 0101, 1511
VIDEOTON 2481
VORTEC 0101, 0651
VOXSON 0411, 0451, 0491,
1021, 1081
WALTHAM 0451
WATSON 0431, 2201, 2241
WATT RADIO 0021, 0061, 0261,
0591, 0641, 0761,
1091, 1971, 1981,
2001
WEGA 0141, 1081, 1981
WEGA COLOR 1021
WELTBlick 0101
WESTON 1621
WHITE WESTINGHOUSE
0101, 0261, 0431,
0591, 0761, 1401,
1541
YOKO 0601, 1511
ZANUSSI 0071, 0101, 0351,
0411, 0451, 0951,
1901, 2061, 2101,
2111
ZOPPAS 0451

CABLE TV

CABLETIME 1446, 1456, 1476
CLYDE CABLEVISION
1426
FILMNET 1396, 1436
FRANCE TELECOM 1386
GEC 1426
JERROLD 1416
MOVIE TIME 1466
NSC 1466
PHILIPS 1386
PIONEER 0006
SAMSUNG 1496
SCIENTIFIC ATLANTA
1486, 1506
STARCOM 1416
STS 1466
TANDBERG 1366
TELE 1436
TELE +1 1436
TELESERVICE 1406, 1476
TUDI 1376
UNITED CABLE 1416
ZENITH 1406

SATELLITE TUNER

AKAI 1276
ALBA 0826, 1276
AMSTRAD 0166, 0796, 1016,
1026, 1296
ANKARO 0476
AST 0406
ASTRA 0126
BARCOM 0476
BLAUPUNKT 0966
BMC SATELLITE 0106
BRITISH TELECOM 1276
BUSH 0826
BUSH (UK) 0956
CAMBRIDGE 0196, 1276
CANAL PLUS (FRANCE)
1536
CHAPARRAL 0016, 0696, 1006
COLUMBUS 0616
CONNEXIONS 0306, 0426
DISCUS ELIPSE 0856, 0866
DISKXPRESS 0426, 0476
DRAKE 1516
ECHOSTAR 0226, 0236, 0606,
0626, 0666, 0926,
0996, 1046, 1056,
1066, 1106
ELTA 1286
ELTA SAT 0146
EURODEC 1226, 1236, 1246
FERGUSON 0046, 0176, 0186,
0296, 0846, 0956,
1306
FINLUX 0976
FRACARRO 0026, 0536, 0776
FUBA 0476, 0616, 0636,
1056
GIUCAR RECORD 0206, 0336
GRUNDIG 0176, 0946, 0956,
0966
HIGH PERFORMANCE
0916
HIRSCHMANN 0756, 0966
HITACHI 0446, 0516, 0706,
0946
ICX INTERNATIONAL 0886
ITT 0066, 0126, 0176,
0446, 1156
ITT/NOKIA 0066, 0126, 0176,
0446, 1156
JEEMON 0146
JERROLD 0846, 0986
JOHANSSON 0246
JVC 1276
KATHREIN 0116, 0266, 0276,
0366
KOSMOS 0266
KYOSTAR 1036, 1086
LENG 0246
LIFESAT 1326, 1346, 1356
LUXOR 0126, 0136, 0446,
0466, 0506, 1156
0356
MACAB
MASPRO 0016, 0116, 0256,
0956
MEDION 1326, 1346
METZ 0966
MICROMAXX 1326, 1346
MITSUBISHI 0966
MORGANS 0596
MURATTO 0406
NEC 0286, 0316, 0766,
0786, 0836
NETWORK 0046
NIKKO 1136, 1146

NOKIA 0066, 0126, 0176,
0446, 1156, 1166,
1336
NORSAT 0786
OTTO VERSAND 0966
PACE 0046, 0176, 0296,
0936, 0956, 1306,
1566, 1576
PACE MSS 0946
PACE SKY DIGITAL BOX (UK)
1526
PALCOM 0616, 0686, 0706
PALSAT 0396
PALTEC 0706
PANASONIC 0806, 1306
PANSAT 1076
PHILIPS 0326, 0346, 0476,
0956, 1126, 1186,
1196, 1206, 1216,
1306, 1316
PROSAT 1176
PTT TELECOM 0306, 0896
QUELLE 0966
RADIX 1056
REDIFFUSION 0316, 0786
RFT 1186, 1196, 1206,
1216
SAGEM 1256, 1546
SAKURA 0566, 0816
SALORA 0066, 0126, 0136,
0446, 0456, 0486,
0496, 0576
SAMSUNG 0746, 0756
SAT 0406
SATCOM 0896
SATECO 0646
SECTOR 1266
SEDEA 1096
SENTRA 0416
SIEMENS 0896, 0966
SINTRACK 0906
SKYLAB 0476
SKYSCAN 0876
SONY 0736, 0946
STELLA 0306
STRONG 0156, 0396, 1036,
1086
STV 0636
TANDBERG 1116
TANDY 0916
TANTEC 0616
TATUNG 0516, 0546
TECHNISAT 0086, 0096, 0526,
0556, 1056
TELECOM 0306
TELEMAX 0586
THORN-FERGUSON 0046, 0076,
0176, 0186,
0956
TOSHIBA 0946
TPS (FRANCE) 1546
TRIAD 0406
UNIDEN 0036, 0216, 0676,
0716, 0726
US ELECTRONICS 0886
VORTEC 0756, 1036, 1076
VTECH 0436
WINERSAT 0246
WISI 0056, 0356, 0376,
0386, 0406, 0656,
1056, 1156
WOLSEY 0916
XCOM MULTIMEDIA 1556
XSAT (FRANCE) 1556
ZEHNDER 0266, 0406
ZENDER 0406

VCR

AIWA 0042, 0352, 0432
AKAI 0042, 0422, 0492,
0582, 0612, 0642,
0652, 0762, 0912
ALBA 0002, 0112, 0282,
0332, 0342, 0972
AMSTRAD 0322, 0432, 0452
ANITECH 0002
ANITSCH 1002
ASA 0012, 0052
AUDIOSONIC 0002
BAIRD 0042, 0282, 0492
BANG & OLUFSEN 0042
BAUR 0052, 0062, 0812
BLAUPUNKT 0062, 0092, 0252,
0462, 0672, 0992
BRIONVEGA 0032
BUSH 0002, 0282, 0332,
0342, 0512, 0972
BUSH (UK) 0812
CAPEHART 0112
CGE 0042, 0432, 0762
CRAIG 0072, 0482
CROWN 0112, 0282, 0622
DAEWOO 0112, 0282, 0622
DANSAI 0012
DAYTRON 0112
DECCA 0042, 0052, 0432,
0942
DECCA (UK) 0052
DEGRAAF 0052, 0132, 0432,
0532, 0602
DIXI 0442
DUAL 0042, 0632
DUMONT 0052, 0432, 0532
DYNATECH 0432
DYNATRON 0012
ELBE 0122
ELIN 0072
EMERSON 0012, 0162, 0202,
0432, 0512, 0522
0012
ERRES
FERGUSON 0042, 0712, 0722,
0852, 0902, 1012,
1022, 1082
FIDELITY 0432
FINLANDIA 0052, 0532
FINLUX 0012, 0042, 0052,
0082, 0262, 0382,
0432, 0462, 0492,
0532, 0572, 0602,
0912
FIRST LINE 0002, 0912
FISHER 0162, 0482, 0532,
0542, 0572, 0592
FORMENTI-PHOENIX
0012, 0052
FRONTECH 0112
FUNAI 0432
GBC 0002
GEC (UK) 0022, 0052
GELOSO 0002
GENERAL TECHNIC 1172
GOLDSTAR 0012, 0122, 0812,
0952
GOODMANS 0002, 0072, 0282,
0432, 0502
GOODMANS (UK) 0002
GRAETZ 0022, 0042
GRANADA 0052, 0132, 0532,
0572

| | | | | | |
|---------------|--|---------------|---|--------------------|---|
| GRANADA (UK) | 0052, 0092, 0462, 0602, 0812, 0822 | NOKIA | 0022, 0032, 0042, 0072, 0292, 0492, 0532, 0572, 0762, 1152 | SINUDYNE | 0052, 0382, 0442, 0932 |
| GRUNDIG | 0052, 0062, 0092, 0232, 0252, 0262, 0752, 0802 | NORDMENDE | 0042, 0102, 0142, 0192, 0222, 0242, 0392, 0402, 0632, 0732, 0742, 0762, 0782, 0792, 0832, 0842, 0872 | SONOKO | 0282 |
| HANSEATIC | 0052, 0812 | OLYMPUS | 0462 | SONY | 0432, 0552, 0682, 0692, 0942, 0952, 0962, 1122, 1132 |
| HARMAN/KARDON | 0122, 0922 | OPTONICA | 0132, 0502 | STS | 0602 |
| HCM | 0002 | ORION | 0162, 0202, 0312, 0442, 0512, 0522, 0982 | SUNKAI | 0512 |
| HINARI | 0002, 0202, 0412, 0442, 0522 | OSAKA | 0432 | SUNSTAR | 0432 |
| HITACHI | 0042, 0172, 0292, 0432, 0602, 0662, 0812, 1022 | OSAKI | 0002, 0012, 0432 | SYLVANIA | 0432, 0912 |
| IMPERIAL | 0072, 0432 | OTTO VERSAND | 0052, 0062, 0812 | SYMPHONIC | 0432, 0912 |
| INGERSOL | 0442 | PANASONIC | 0022, 0212, 0462, 0672, 0992, 1092, 1102, 1182 | TANDBERG | 0062, 0162, 0522, 0932 |
| INNO HIT | 0002, 0052, 0072 | PENTAX | 0172, 0602 | TASHIKO | 0132, 0432 |
| INNOVATION | 1142, 1162, 1172 | PERDIO | 0432 | TATUNG | 0042, 0052, 0432, 0922 |
| INTERFUNK | 0022, 0052 | PHILCO | 1062 | TCM | 1142, 1162, 1172 |
| IRRADIO | 0002, 0012 | PHILIPS | 0052, 0082, 0092, 0152, 0182, 0362, 0372, 0382, 0472, 0502, 1072 | TEAC | 0042, 0432 |
| ITT | 0022, 0032, 0042, 0072, 0292, 0492, 0532, 0572, 0762 | PHONOLA | 0052, 0152 | TECHNICS | 0462 |
| ITT-NOKIA | 0022, 0032, 0042, 0072, 0292, 0492, 0532, 0572, 0762 | PILOT | 0012 | TEKNIKA | 0012, 0432 |
| JENSEN | 0042 | PIONEER | 0052, 0142, 0372, 0472 | TELEFUNKEN | 0042, 0192, 0632, 0732, 0742, 0762, 0782, 0882, 0892 |
| JVC (VICTOR) | 0042, 0102, 0142, 0272, 0742, 0762, 0782, 0902 | PORTLAND | 0112 | TEMPEST | 1032, 1042, 1052 |
| KARCHER | 0052, 0072, 0812 | PROLINE | 0432 | TENOSAL | 0002 |
| KENDO | 0492 | PYE | 0052, 0152 | THOMSON | 0042, 0102, 0142, 0192, 0402, 0632, 0762 |
| KENWOOD | 0042, 0142, 0572 | QUARTZ | 0572 | THORN | 0042, 0902 |
| LIFETEC | 1142, 1162, 1172 | QUELLE | 0012, 0032, 0042, 0052, 0062, 0072, 0092, 0202, 0462, 0522, 0942 | THORN-FERGUSON | 0042, 0222, 0302, 0712, 0722, 0742, 0762, 0852, 0862, 0872, 0902 |
| LLOYD | 0432 | RADIONETTE | 0022 | TMK | 0522 |
| LOEWE OPTA | 0052, 0092, 0152 | REALISTIC | 0012, 0072, 0132, 0432, 0482, 0502, 0532, 0572 | TONSAI | 0002 |
| LOGIK | 0002, 0072, 0442 | RET | 1072 | TOSHIBA | 0042, 0622, 0912 |
| LUMA | 0162 | REX | 0042, 0742, 0782 | TOTEVISION | 0012, 0072 |
| LUXOR | 0492, 0572, 0812 | RICOH | 0952 | TRIUMPH | 0922 |
| M ELECTRONIC | 0432 | SABA | 0042, 0142, 0192, 0222, 0242, 0392, 0632, 0732, 0742, 0762, 0772, 0782, 0792, 0872 | UHER | 0042, 0072 |
| MAGNADYNE | 0052 | SAISHO | 0162, 0202, 0292, 0442, 0512, 0522, 0972 | ULTRAVOX | 0032 |
| MAGNASONIC | 0572 | SALORA | 0192, 0572, 0812, 0822, 0912 | UNITECH | 0072 |
| MANESTH | 0012 | SAMSUNG | 0052, 0072, 0622, 0652, 1192 | VECTOR RESEARCH | 0122 |
| MARANTZ | 0012, 0052, 0092, 0122, 0502 | SANSUI | 0042, 0142 | VIDEO | 1162, 1172 |
| MARK | 0012 | SANYO | 0482, 0532, 0562, 0572 | WELTBlick | 0012 |
| MARTA | 0012 | SBR | 0052, 0152, 0182 | WHITE WESTINGHOUSE | 0032 |
| MATSUI | 0012, 0442, 0512, 0522, 0812, 0972 | SCHAUB LORENZ | 0022, 0042 | XENON | 0162 |
| MEDION | 1142, 1162, 1172 | SCHNEIDER | 0002, 0012, 0052, 0072, 0432 | YAMAHA | 0042, 1202 |
| MEMOREX | 0012, 0132, 0432, 0482, 0532, 0572 | SEG | 0002, 0072 | YOKO | 0012, 0062, 0072 |
| METZ | 0062, 0092, 0932 | SEI-SINUDYNE | 0442 | | |
| MGA | 0912 | SELECO | 0042 | | |
| MICROMAXX | 1142, 1162, 1172 | SENTRA | 0112 | | |
| MINERVA | 0062, 0092, 0252 | SHARP | 0132, 0502, 0702 | | |
| MINOLTA | 0172, 0602 | SHINTOM | 0002 | | |
| MITSUBISHI | 0052, 0062, 0142, 0912, 0922 | SIEMENS | 0062, 0092, 0252, 0572 | | |
| MTC | 0072, 0432 | | | | |
| MULTITECH | 0002, 0052, 0062, 0282, 0432 | | | | |
| MURPHY | 0432 | | | | |
| N.E.I. | 0012, 0052 | | | | |
| NATIONAL | 0462 | | | | |
| NEC | 0042, 0122, 0142 | | | | |
| NECKERMANN | 0032, 0042, 0052, 0072, 0092, 0202, 0522, 0572, 0762, 0812 | | | | |
| NIKKAI | 0112 | | | | |
| NOBLIKO | 0092 | | | | |

LD PLAYER

| | |
|-----------|---------------------------|
| AIWA | 0137 |
| FUNAI | 0137 |
| HITACHI | 0047 |
| MAGNAVOX | 0077 |
| PANASONIC | 0027 |
| PIONEER | 0037 |
| RCA | 0067 |
| REALISTIC | 0137 |
| SAMSUNG | 0017, 0087 |
| SONY | 0057, 0097, 0107, 0117 |
| VICTOR | 0127 |
| YAMAHA | 0007 |

CD PLAYER

| | |
|----------------------|---|
| ACCUPHASE | 0315 |
| ADC | 0865 |
| ADCOM | 0785, 1015 |
| AKAI | 0115, 0125, 0725, 0735, 0745, 0935, 1155 |
| ARCAM | 1875 |
| ARCAM-ROTEL | 0165 |
| AUDIO-TECHNICA | 0835 |
| AUDIOSONIC | 0155 |
| AIWA | 1105, 1235, 1245, 1765, 1915, 1935 |
| BSR | 0875 |
| CALIFORNIA AUDIO LAB | 1075 |
| CARRERA | 0555, 0875 |
| CARVER | 0825, 1415 |
| CYRUS-ROTEL | 0205 |
| DENON | 0045, 0955, 1045, 1595, 1795, 1805 |
| DUAL | 1005 |
| ELIN | 0185 |
| EMERSON | 1015, 1285, 1675 |
| FISHER | 0105, 0595, 0605, 0825, 1165, 1175 |
| GENEXXA | 0525, 0825, 0855, 0875, 0995, 1265, 1285, 1345, 1355, 1485, 1575, 1675, 1715, 1825 |
| GOLDSTAR | 0555, 1185, 1195, 1585 |
| GRUNDIG | 0175 |
| HARMAN KARDON | 0325, 0495, 0565, 1135, 1145, 1155 |
| HITACHI | 0065, 0585, 0685, 0945, 1005, 1015, 1225, 1545 |
| INNOVATION | 1995, 2005, 2015 |
| ITT-NOKIA | 0185 |
| JVC (VICTOR) | 0385, 0395, 0455, 0575, 0585 |
| KARCHER | 0485 |
| KENWOOD | 0025, 0055, 0145, 0215, 0595, 0675, 0695, 0705, 0715, 0925, 1355, 1485, 1575, 1675, 1715, 1825 |
| KORTING | 0175 |
| LIFETEC | 2015 |
| LIGHT CONTROL | 1155, 1645, 1655, 1665 |
| LINN | 0165, 1875 |
| LUXMAN | 0265, 0275, 0795, 0805, 1295, 1305, 1555, 1925 |

DVD PLAYER

| | |
|------------|---------------------------|
| AKAI | 0108\ |
| DENON | 0368 |
| HITACHI | 0388 |
| JVC | 0168, 0348 |
| KENWOOD | 0288 |
| MAGNAVOX | 0248 |
| MITSUBISHI | 0268 |
| ONKYO | 0128, 0248 |
| PANASONIC | 0048 |
| PHILIPS | 0188, 0248 |
| PIONEER | 0208, 0228 |
| PROSCAN | 0308 |
| RCA | 0308 |
| SAMSUNG | 0148 |
| SHARP | 0068 |
| SONY | 0028 |
| TECHNICS | 0048 |
| THOMSON | 0328 |
| TOSHIBA | 0088, 0248 |
| YAMAHA | 0008, 0048, 0188, 0248 |
| ZENITH | 0248 |

LUXOR 0185, 1895, 1905
MAGNAVOX 1865, 1875
MARANTZ 0165, 0175, 0545,
0665, 1275, 1335,
1405, 1505, 1875,
1955
MATSUSHITA 1095, 1605
MCS 0535
MEDION 0075, 1995, 2005,
2015
MEMOREX 0525, 1015, 1265,
1275, 1285, 1675
MGA 1125
MICROMAXX 2015
MISSION 0165, 1875
MITSUBISHI 1125, 1205
NAD 0135, 0255, 0285,
0295, 0305, 0345,
0755, 0765, 1315,
1325
NAKAMICHI 0635, 0645, 1565
NEC 0405, 0535, 0775,
0785
NECKERMAN 0155, 0225
NIKKO 0835, 1165
OCEANIC 0185
OKANO 0155, 0225
ONKYO 0885, 1385, 1425,
1455, 1515
PANASONIC 1055, 1075, 1615,
1625
PHILIPS 0165, 0175, 0195,
1865, 1875
PIONEER 0095, 0335, 0425,
0435, 0445, 0525,
0855, 1035, 1945
PROTON 0905, 1875
QUASAR 1075
RADIOLA 1845, 1855
RADIOTONE 0485
REALISTIC 0825, 1015, 1265,
1275, 1285, 1575
ROTEL 1875
SABA 1005
SAE 1875
SALORA 0185
SANSUI 0415, 0965, 0975,
0985, 1255, 1675,
1875
SANYO 0625, 0825, 0845,
0915
SCHNEIDER 1845, 1855
SCOTT 1285, 1675
SHARP 0025, 0035, 1025,
1115, 1275, 1635,
1785, 1815, 1825,
1835
SHERWOOD 1275, 1445
SIEMENS 1085
SIGNATURE 1155
SONY 0345, 0355, 0365,
0375, 0865, 1685,
1695, 1705, 1715,
1725, 1735, 1745
SYLVANIA 1875
TANDBERG 1885
TASHIKO 1525
TCM 1985, 2015
TEAC 0235, 0245, 1275,
1365, 1375, 1395,
1435, 1465, 1475
TECHNICS 0465, 0475, 1065,
1075, 1625
TELEFUNKEN 1005
THETA DIGITAL 1865

THOMSON 1005
TOSHIBA 0755, 0765
VECTOR RESEARCH
0555, 0865
YAMAHA 0005, 0015, 0085,
0345, 0615, 0655,
0815, 0835, 0895,
1815

CD RECORDER/CD-RW

HITACHI 0304
JVC 0334
MARANTZ 0314, 0324
PHILIPS 0274
PIONEER 0284, 0294
YAMAHA 0244

MD RECORDER

KENWOOD 0214
SHARP 0264
PIONEER 0254
SONY 0224
YAMAHA 0024, 0224, 0234

TAPE DECK

AKAI 0124
DENON 0204
GRUNDIG 0134
HARMAN 0044
JVC 0194
KENWOOD 0164
KORTING 0134
LUXMAN 0054, 0064, 0074,
0084
MARANTZ 0134, 0144
NAD 0174
ONKYO 0184
PHILIPS 0134, 0144, 0154
PIONEER 0034, 0114
SONY 0094, 0104
YAMAHA 0004, 0014



YAMAHA ELECTRONICS CORPORATION, USA 6660 ORANGETHORPE AVE., BUENA PARK, CALIF. 90620, U.S.A.
YAMAHA CANADA MUSIC LTD. 135 MILNER AVE., SCARBOROUGH, ONTARIO M1S 3R1, CANADA
YAMAHA ELECTRONIK EUROPA G.m.b.H. SIEMENSSTR. 22-34, 25462 RELLINGEN BEI HAMBURG, F.R. OF GERMANY
YAMAHA ELECTRONIQUE FRANCE S.A. RUE AMBROISE CROIZAT BP70 CROISSY-BEAUBOURG 77312 MARNE-LA-VALLEE CEDEX02, FRANCE
YAMAHA ELECTRONICS (UK) LTD. YAMAHA HOUSE, 200 RICKMANSWORTH ROAD WATFORD, HERTS WD1 7JS, ENGLAND
YAMAHA SCANDINAVIA A.B. J A WETTERGRENS GATA 1, BOX 30053, 400 43 VÄSTRA FRÖLUNDA, SWEDEN
YAMAHA MUSIC AUSTRALIA PTY, LTD. 17-33 MARKET ST., SOUTH MELBOURNE, 3205 VIC., AUSTRALIA

YAMAHA CORPORATION
Printed in Malaysia ID V722690-1

Connection Guide (when listening to a digital 5.1-channel source)

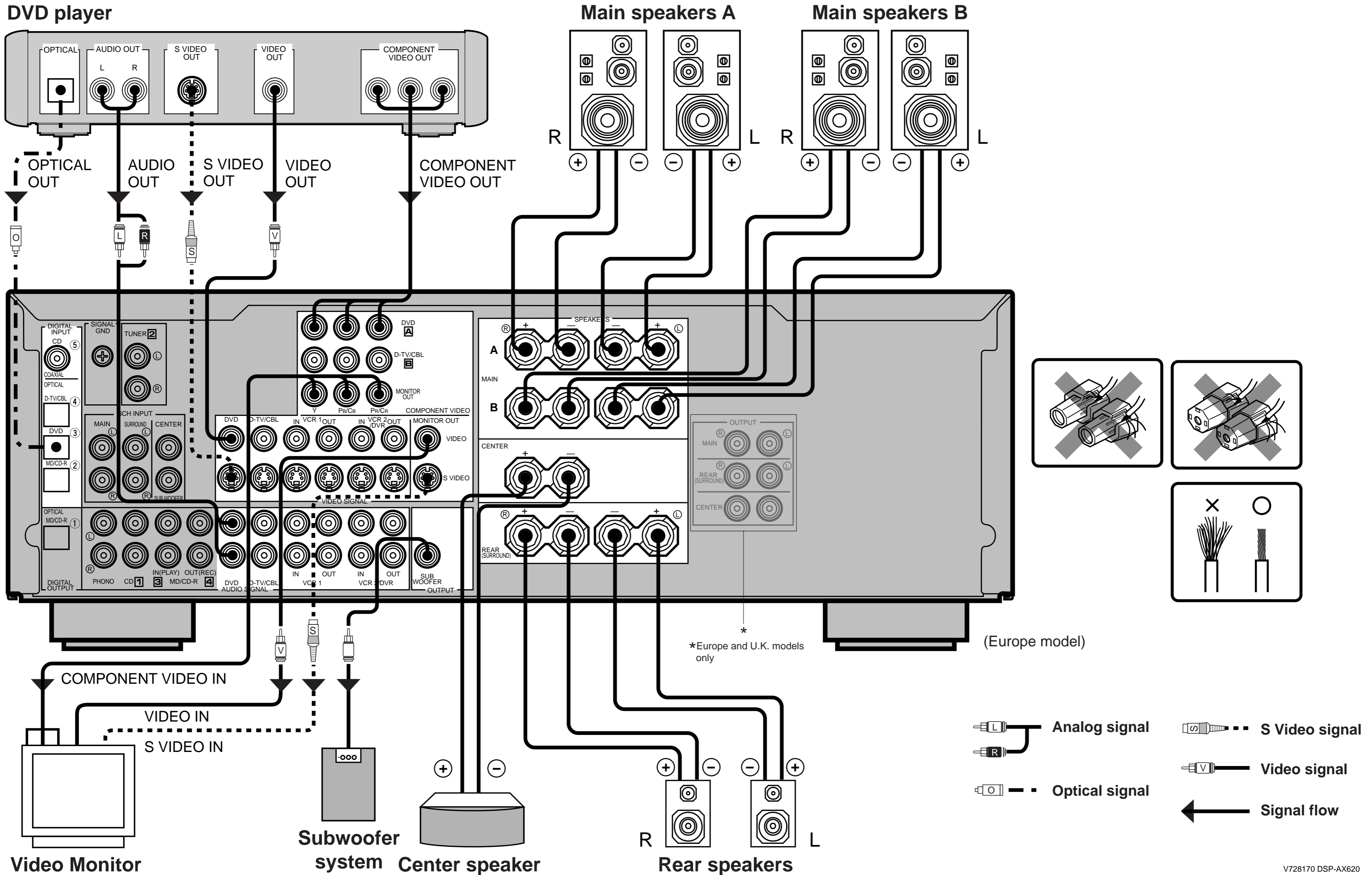

Quick Reference Card

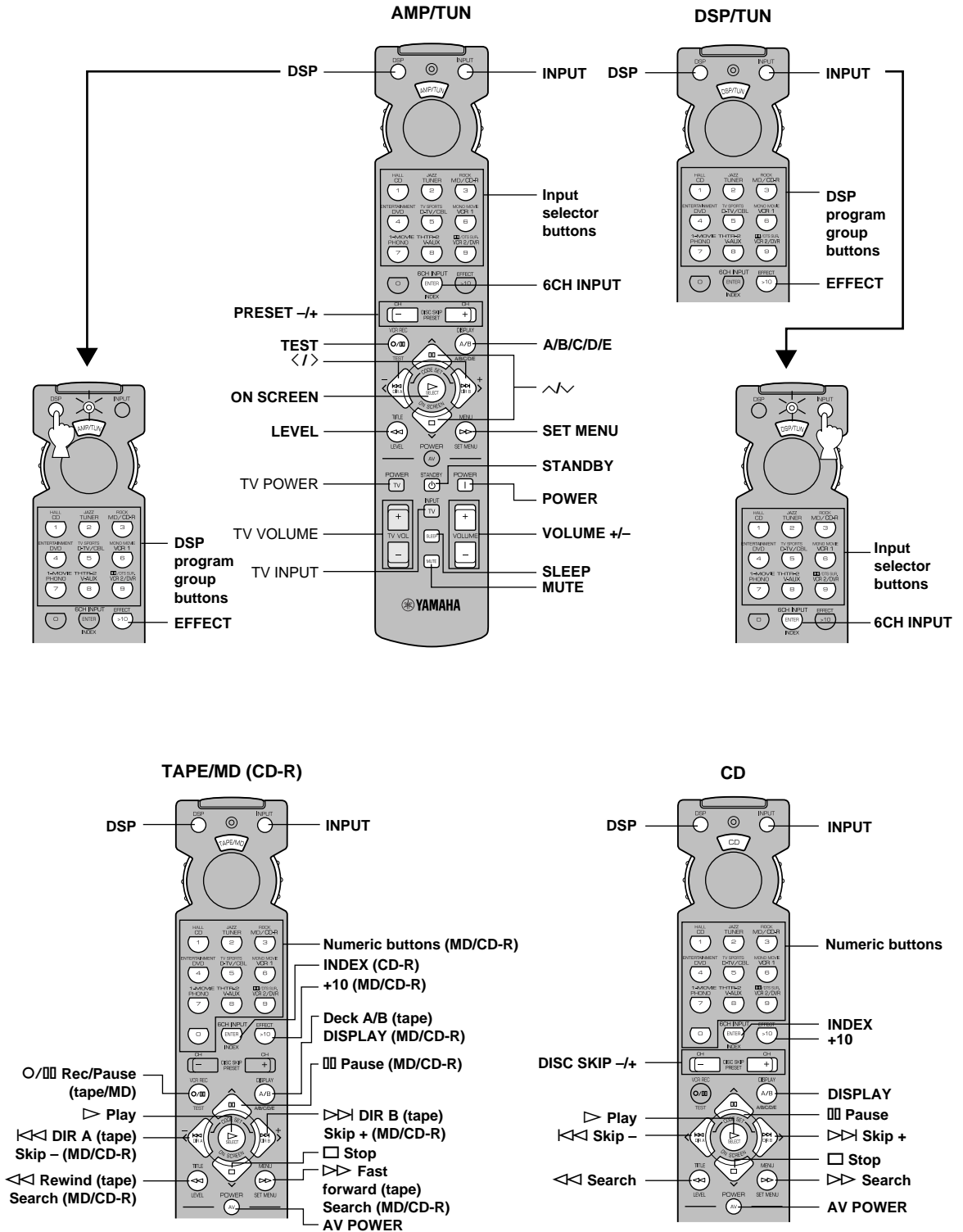

Quick Reference Card

DVD/LD

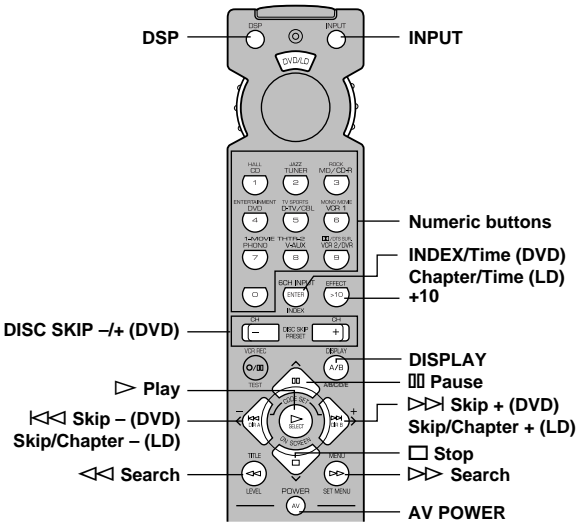

DVD MENU

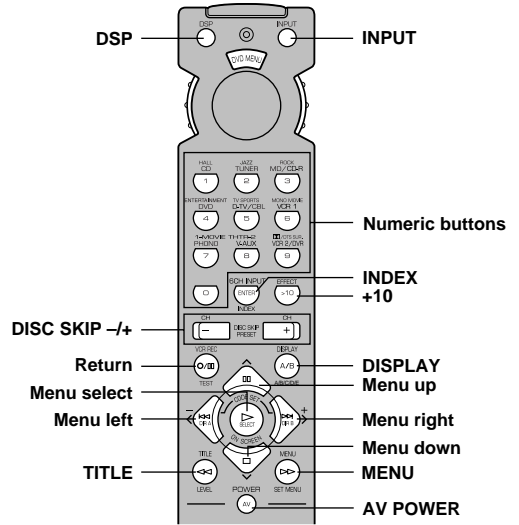

VCR

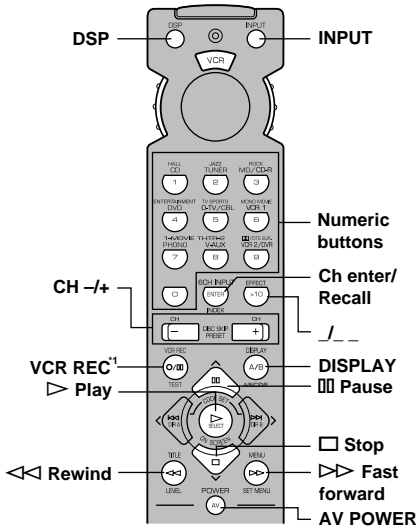

TV

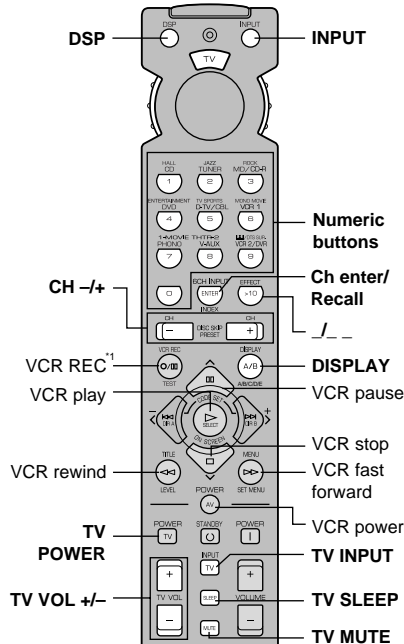

CBL/SAT

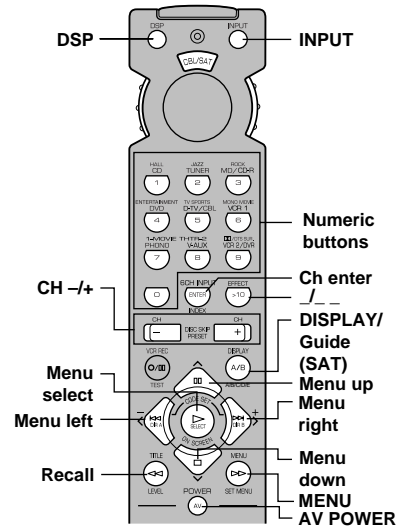

*1 Press this button twice to start recording.
Appuyer deux fois sur cette touche pour commencer l'enregistrement.
Drücken Sie diese Taste zweimal, um die Aufnahme zu starten.
Tryck två gånger på den här knappen för att börja spela in.

Premere due volte questo tasto per iniziare la registrazione.
Presione dos veces este botón para empezar a grabar.
Druk tweemaal op deze toets om met opnemen te beginnen.
按此按钮两次即可开始录像。